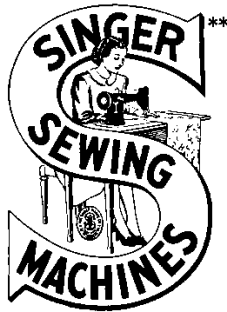


Singer 42-5

Form 8898—Revised
August, 1929
PRINTED IN U. S. A.

LIST OF PARTS



MACHINE No. 42-5

**** A TRADE MARK OF
THE SINGER MANUFACTURING COMPANY**

INSTRUCTIONS FOR OILING

To ensure easy running and prevent unnecessary wear of the parts which are in movable contact, the machine requires oiling and when in continuous use, "TYPE B" or "TYPE D" OIL, sold only by Singer Sewing Machine Company, should be applied at least twice each day to all oil holes marked "OIL", as instructed in Form 7919.

"TYPE D" OIL is stainless.

COPYRIGHT, U. S. A.,
1917, 1918, 1920, 1921, 1922, 1923 AND 1929
BY THE SINGER MANUFACTURING COMPANY
ALL RIGHTS RESERVED FOR ALL COUNTRIES

INDEX

	PAGE
ACCESSORIES.....	13
BINDER (ADJUSTABLE) No. 36344.....	15
" " " 120061.....	14
" " " 120247.....	14
" " " 120248.....	14
BINDERS ON SHANK.....	15
BOBBIN WINDER No. 5762.....	17
" " " 27549.....	18
" " " 41449.....	19
CORDER (ADJUSTABLE) No. 28329.....	16
" " " 120207.....	16
FOR COVERING CORD WITH THIN LEATHER.....	16
HEMMERS ON SHANK.....	16
KNEE LIFTER PARTS (POWER TABLE).....	19
" " " (STAND).....	20
MACHINE No. 42-5.....	7
NUMERICAL LIST OF PARTS.....	25
OBSOLETE PARTS.....	23
PIPING ATTACHMENTS.....	17
PRESSER FEET.....	17
STAND (ROCKING TREADLE).....	21
TRIMMINGS FOR END AND BACK LEAF TABLE.....	22

INSTRUCTIONS FOR ORDERING

In ordering from this list, use **ONLY** the part NUMBER in the **FIRST** column.

The number stamped on a Sewing Machine part is in every case the number of the single part only.

Every combination of parts sent out as such has its specific number, which, although not stamped on the parts, must be used when ordering the combination.

Each number always indicates the **SAME PART** in whatever list it appears, or for whatever machine.

The letters after some of the numbers indicate the style of finish only, as follows:

- A—Hardened, Polished, Nickel Plated and Buffed
- B—Polished, Nickel Plated and Buffed
- C—Hardened Only
- D—Polished Only
- E—Soft, Not Polished
- F—Hardened and Polished
- H—Blued
- J—Nickel Plated Only
- K—Hardened and Nickel Plated
- L—Brass Plated
- M—Oxidized
- P—Japanned
- R—Merlized
- T—Copper Plated
- T. A.—Hardened, Polished, Copper and Nickel Plated and Buffed.
- T. B.—Copper and Nickel Plated and Polished.
- T. J.—Copper and Nickel Plated Only.
- T. K.—Hardened, Copper and Nickel Plated.
- T. M.—Copper Plated and Oxidized.
- T. L.—Copper and Brass Plated.
- U—Zinc Plated
- V—Silver Plated
- W—Polished and Nickel Plated
- Z—Chromium Plated

These letters **MUST BE USED** when they appear in the list; and **AFTER** the number **as** in the list.

In this series:

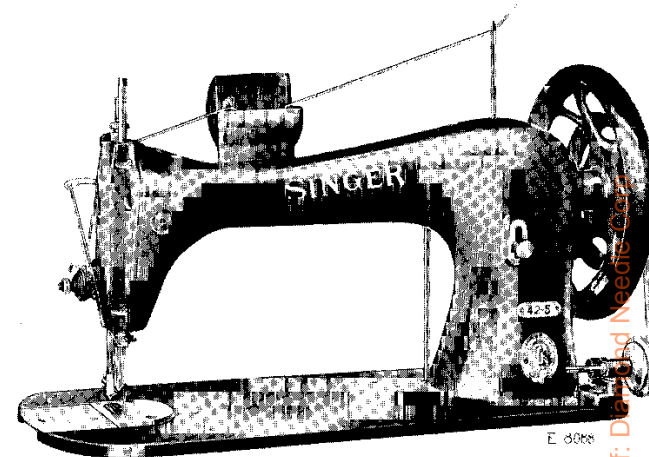
- 1 to 1500 and 50001 to 51500 are Screw Numbers.
- 1501 to 1800 and 51501 to 51800 are Nut Numbers.
- 1801 to 2000 and 51801 to 52000 are Roller Numbers.
- 2001 to 50000 and 52001 and upward are numbers of Machine Parts.

The figures in the second column refer only to the plates, illustrating the parts, and are **NOT TO BE USED** in ordering.

Parts marked with an asterisk (*) are furnished only when repairs are made at factory.

LIST OF PARTS COMPLETE

FOR



MACHINE No. 42-5

CYLINDER SHUTTLE, DROP FEED, ALTERNATING PRESSERS

NO.	PLATE	NAME
*5801	—	Arm with 4448 and 4449.....
2002	3636	" Dowel Pin.....
4448	695	" Oil Tube for intermediate bearing..
123E	691	" Screw.....
6178	3628	" Shaft for 3011.....
6179	3628	" " " 5977.....
*13257	—	" " " 6179 with 3032 and 8184..
3005	3629	" " Bushing (back).....
448c	691	" " " " Set Screw....
*4449	—	" " " " (front).....
144d	691	" " Screw.....
4288	3629	" Side Cover.....
286d	692	" " " Thumb Screw.....
5811	695	" Spool Pin and Thread Eyelet.....
8879	7801	" " " Washer (cloth).....

From the library of: DePaul Needle Co.

PARTS FOR MACHINE No. 42-5

NO.	PLATE	NAME
1823	693	Lifting Presser Bar Bracket Roller and Stud.....
8191	3631	Lifting Presser Bar Lifter.....
598c	691	" " " " Screw.....
4725	695	" " " " Lifting Bracket.....
4726	695	" " " " " Guide Pin.....
32675	7808	Lifting Presser Bar Spring.....
2070	3632	" " " " Washer.....
5816	3631	" " Foot.....
193d	691	" " " " Screw.....
5981	—	Loose Wheel Attachment complete, Nos. 5977 and 5993.....
4264	3630	Needle Bar.....
*4898	3633	" " Connecting Link with 390E..
56764	—	" " " " 4898 with 15472.....
390E	692	Needle Bar Connecting Link Adjusting Screw.....
15472	3633	Needle Bar Connecting Stud with 155c..
155c	691	" " " " Set Screw..
4265	—	" Clamp with 196f.....
4865	3632	Needle Clamp complete, Nos. 651d, 4265 and 4266.....
4266	3632	Needle Clamp Thread Guide.....
651d	692	" " " " Screw.....
196f	3632	" " " " Screw.....
5778	3629	Oil Cup.....
5779	695	" " Pad (felt).....
211d	692	" " " " Screw.....
7071	695	" " " " Washer.....
135d	691	" " " " Screw.....
5780	695	" " Thread Eyelet.....
5781	—	Oil Cup complete, Nos. 211d, 5778 to 5780 and 7071.....
*5970	3629	Oscillating Rock Shaft with 11165.....
8163	—	" " " " 5970 with 635c, 1513j and 56812.....
3052	3629	Oscillating Rock Shaft Hinge Pin.....
56812	—	" " " " " " 3052 with 1513j.....
1513j	693	Oscillating Rock Shaft Hinge Pin Nut...
635c	692	" " " " " " Screw Bearing.....
1513j	693	Oscillating Rock Shaft Hinge Pin Screw Bearing Nut.....
11165	695	Oscillating Rock Shaft Oil Pad.....
8166	3630	" Shaft.....

PARTS FOR MACHINE No. 42-5

NO.	PLATE	NAME
5917	3634	Oscillating Shaft Collar with 453c.....
453c	692	" " " " Set Screw.....
5999	—	" " " " Crank.....
6000	3632	Oscillating Shaft Crank complete, Nos. 453c, 1513j, 1885 and 5999.....
2049	3632	Oscillating Shaft Crank Pin.....
453c	692	" " " " Set Screw.....
1885	693	" " " " Roller with 190d, 1054c and 5968.....
190d	691	Oscillating Shaft Crank Roller Cap Screw
5968	3632	" " " " " " " " Washer.....
1054c	3632	Oscillating Shaft Crank Roller Screw Stud
1513j	693	" " " " " " " " Nut.....
262j	692	Pressure Regulating Thumb Screw.....
14535	685	Shuttle Bobbin.....
13258	7809	" " " " Cylinder.....
13259	—	" " " " 13258 with 773f and 13264.....
13266	7808	Shuttle Cylinder Hinge Pin.....
13261	7808	" " " " Latch.....
229d	7808	" " " " " " Screw.....
13262	7809	Shuttle Frame.....
13263	—	" " " " 13262 with 229d and 13261 773f.....
773f	692	Shuttle Tension Regulating Screw.....
13264	7808	" " " " Spring.....
13265	7809	Shuttle (cylinder) 2½ in. diam., complete, Nos. 13259, 13263, 13266 and 14535...
5833	3634	Shuttle Driver.....
2022	3634	" " " " Pin.....
5848	3635	" " " " Race Back.....
5939	3635	" " " " " " Spring.....
5842	3634	" " " " " " Rest Pin.....
933d	3634	" " " " " " Screw.....
5965	3634	" " " " " " Steady Pin.....
5843	3635	" " " " " " Body.....
8193	—	" " " " " " 5843 with 5842, 5844, 5845 and two each 219d, 934j and 5965
5844	3636	Shuttle Race Cap (left).....
5845	3636	" " " " (right).....
219d	691	" " " " " " Screw (large).....
934j	3636	" " " " " " (small).....
5841	—	Shuttle Race complete, Nos. 933d, 5848, 5939 and 8193.....
5943	3635	Shuttle Race Frame with 5944.....
575e	3636	" " " " " " Clamping Screw....

NO.	PLATE	NAME
5944	3636	Shuttle Race Frame Steady Pin.....
141D	3636	" " Screw.....
5945	—	" " Slide.....
5946	3635	Shuttle Race Slide complete, Nos. 5945, 5947 and two 725E.....
5947	3635	Shuttle Race Slide Spring.....
725E	3636	" " " " Screw.....
1560c	693	Tension Regulating Thumb Nut.....
2103	685	" Spring.....
817c	693	" Stud.....
448c	691	" " Set Screw.....
2105	3636	" Thread Guard.....
5983	3636	" Washer (felt).....
5984	3636	" " (steel).....
5795	3636	" Wheel with 5796.....
*5796	—	" " Flange.....
5797	—	Tension complete (wheel) Nos. 817c, 1560c, 2103, 5795 and two each 5983 and 5984.....
12296	3636	Thread Eyelet (side of arm).....
2455	685	" Retainer Disc.....
1562j	693	" " Regulating Thumb Nut.....
418D	693	" " Screw Stud.....
10141	685	" " Spring.....
5989	—	Thread Retainer complete, Nos. 418D, 1562j, 10141 and two 2455.....
*8184	—	Thread Take-up Cam.....
5793	3635	" " " 8184 with 446c....
3012	3636	" " " Pin.....
446c	691	" " " Set Screw.....
*5758	3635	" " " Lever with 1819.....
8159	—	" " " 5758 with 1088c..
1088c	3636	" " " Hinge Screw.....
1819	693	" " " Roller and Stud..
5991	3636	" " " Spring.....
2127	3636	" " " Regulator Plate
233D	691	" " " " " "
		Screw.....
8192	3631	Throat Plate for 8190.....
8197	—	" " " Body.....
8198	3647	" " " Needle Hole Strip.....
401E	7801	" " " " " Screw...
8199	3647	Throat Plate complete for 8196, Nos. 8197, 8198 and two 401E.....
5862	3618	Throat Plate for 5899.....
5865	—	" " " Body.....
5866	3618	" " " Needle Hole Strip.....

NO.	PLATE	NAME
401E	7801	Throat Plate Needle Hole Strip Screw...
5867	3618	Throat Plate complete for 8153, Nos. 5865, 5866 and two 401E.....
5880	—	Throat Plate Body.....
5853	—	" " " Needle Hole Strip.....
401E	7801	" " " " " Screw...
5881	3647	Throat Plate complete for 5840, Nos. 5853, 5880 and two 401E.....
5759	3640	Throat Plate for 13252.....
742F	692	Throat Plate Screw.....
3134	3633	Vibrating Presser Bar.....
2361	3633	" " " " Hinge Bracket...
2362	3633	" " " " " Rivet
810D	3633	" " " " " Cap Screw..
4897	3633	" " " " " Lifting Bell Crank
810E	3633	" " " " " " "
		Cap Screw.....
3137	3633	Vibrating Presser Bar Spring.....
337D	692	" " " " " Screw.....
5890	3631	" " " " " Foot.....
5814	3624	" " " " " for 5840.....
217F	691	" " " " " Screw.....
5975	3627	Drip Pan (stand) with four wood screws ½ in. No. 5.....
5976	—	Drip Pan (power table) with four wood screws ½ in. No. 5.....

ACCESSORIES

NO.	PLATE	NAME
27056	3637	Machine Button with wood screw 1¼ in. No. 14 R. H. B.....
41400	3637	Machine Rest Pin (wood).....
120342	3637	Oiler (copper plated) with 120343.....
120343	3637	" Spout, 3½ in. long.....
26026	3637	Screw Driver (large).....
26485	3637	" " (small).....
4347	3637	Wrench for 1513 and 1518.....

BINDER (Adjustable)

TO TURN IN UPPER EDGE ONLY FOR LIGHT OR
MEDIUM WEIGHT MATERIAL

NO.	PLATE	NAME
120242	7790	Bed with 1036c.....
120244	7790	Folder (upper).....

BINDER (ADJUSTABLE)

NO.	PLATE	NAME
120245	7790	Guide (centre).....
120246	7790	" (lower).....
286D	692	" Thumb Screw.....
1036C	7790	Leveling Screw.....
120247	7790	Binder complete, Nos. 286D, 120242 and 120244 to 120246.....
35364	7796	Lifting Presser Foot.....
35365	7796	Vibrating Presser Foot.....

BINDER (Adjustable)

TO TURN IN BOTH EDGES, FOR LIGHT OR MEDIUM WEIGHT MATERIAL

NO.	PLATE	NAME
120242	7791	Bed with 1036C.....
120243	7791	Folder (lower).....
120244	7791	" (upper).....
120245	7791	Guide (centre).....
286D	692	" Thumb Screw.....
1036C	7790	Leveling Screw.....
120248	7791	Binder complete, Nos. 286D and 120242 to 120245.....
35364	7796	Lifting Presser Foot.....
35365	7796	Vibrating Presser Foot.....

BINDER (Adjustable)

FOR 1/2 IN. TO 1 1/2 IN. LEATHER BINDING, FOR SHORT CURVES

NO.	PLATE	NAME
36340	5830	Bed with two each 1036C and 1266C.....
120058	5830	Edge Guide.....
181D	5830	" " Screw.....
41544	5830	" " Washer.....
120059	5830	Guide (lower).....
120060	5830	" (upper).....
286D	5830	" Thumb Screw.....
1036C	7790	Leveling Screw (back).....
1266C	7801	" " (front).....
120061	5830	Binder complete, Nos. 181D, 286D, 36340, 41544 and 120058 to 120060.....
35364	7796	Lifting Presser Foot.....
35365	7796	Vibrating Presser Foot.....

BINDER (Adjustable)

FOR LEATHER BINDING, FOR CANVAS BAGS, LEGGINGS, ETC.

NO.	PLATE	NAME
36340	5807	Bed with two each 1036C and 1266C.....
36341	5807	Edge Guide.....
671D	5807	" " Thumb Screw.....
36342	5807	Guide (lower).....
36343	5807	" (upper).....
286D	5807	" Thumb Screw.....
1036C	7790	Leveling Screw (back).....
1266C	7801	" " (front).....
36344	5807	Binder complete, Nos. 286D, 671D and 36340 to 36343.....
36345	7796	Lifting Presser Foot.....
36346	7796	Vibrating Presser Foot.....

BINDERS ON SHANK

NO.	PLATE	NAME
28307	7797	Binder on Shank.....
28306	7797	Vibrating Presser Foot for 28307.....
28894	3612	Binder on Shank, for carpets.....
35144	3624	" " " " 35145.....
5856	3624	Feed Dog for 35145.....
5816	3624	Lifting Presser Foot for 35145.....
5804	3624	Throat Plate for 5856.....
5814	3624	Vibrating Presser Foot for 35145.....
35145	—	Binder complete, for patent leather or drill strip, to turn top edge under, for carpets, Nos. 5804, 5814, 5816, 5856 and 35144.....

CORDER (Adjustable)

FOR SHORT TURNS ON CUSHIONS

NO.	PLATE	NAME
26795	7798	Cord Guide.....
26796	7798	" " Arm with 26798 and three 6037.....
1044D	7798	Cord Guide Arm Hinge Screw.....
120206	7798	" " Bed with 457C.....
457C	7798	" " " Leveling Screw.....

CORDER (ADJUSTABLE)

NO.	PLATE	NAME
26798	7798	Cord Guide Bracket.....
6037	7798	“ “ “ Rivet.....
190D	691	“ “ Screw.....
120207	7798	Corder complete, Nos. 190D, 1044D, 26795, 26796 and 120206.....
120293	7798	Lifting Presser Foot (grooved).....
120294	7798	Vibrating Presser Foot (grooved).....

CORDER (Adjustable)

FOR BUGGY CUSHIONS

This Corder is the same as No. 120207 with the following exceptions:

NO.	PLATE	NAME
28328	3608	Cord Guide Bed, in place of 120206.....
28329	3608	Corder complete, Nos. 190D, 1044D, 26795, 26796 and 28328.....
28325	3608	Lifting Presser Foot.....
28326	3608	Vibrating Presser Foot.....

NOTE. When ordering Nos. 28325 or 28326 send sample of the cord to be used

FOR COVERING CORD WITH THIN LEATHER

NO.	PLATE	NAME
35291	3603	Feed Dog (grooved).....
28314	3603	Lifting Presser Foot.....
28317	3603	Throat Plate (grooved) for 35291.....
28315	3603	Vibrating Presser Foot.....

HEMMERS ON SHANK

NO.	PLATE	NAME
28333	7799	Hemmer on Shank.....
36013	5708	“ “ “ for $\frac{1}{4}$ in. to $\frac{1}{2}$ in. hem, for canvas.....
36014	—	Hemmer on Shank, for $\frac{3}{8}$ in. to 2 in. hem, for canvas.....
36015	5708	Feed Dog for 36013 and 36014.....
36016	5708	Throat Plate for 36015.....

PRESSER FEET

NO.	PLATE	NAME
26996	7796	Lifting Presser Foot with stitch set.....
28323	7796	“ “ “ “ teeth on bottom of bend of toe part.....
28324	7796	Vibrating Presser Foot with teeth on bottom of bend of forked part.....

PIPING ATTACHMENTS

NO.	PLATE	NAME
36111	7797	Piping Attachment.....
26800	7797	“ “ “ on Shank.....
120099	7797	Lifting Presser Foot for 26800.....
120100	7797	Vibrating Presser Foot for 26800.....

BOBBIN WINDER

NO.	PLATE	NAME
5958	3638	Bracket.....
159D	691	“ Screw.....
5959	3638	Frame.....
5809	—	Frame complete, Nos. 333D, 5761, 5959 to 5961 and 5963.....
46D	691	Frame Hinge Screw.....
5960	3638	Friction Wheel (leather).....
5961	3638	“ “ Washer.....
333D	692	“ “ “ Screw.....
5761	3638	Spindle.....
5963	3638	“ Flange.....
11114	3638	Spring.....
190D	691	“ Screw.....
5762	3638	Bobbin Winder complete, Nos. 46D, 190D, 5809, 5958 and 11114.....

BOBBIN WINDER

(SWINGING AUTOMATIC, RIGHT HAND)
FOR 14535

NO.	PLATE	NAME
15072	7801	Bobbin Position Pin.....
27540	7800	Base.....
27527	7800	Frame.....
50356D	7801	“ Hinge Screw.....
1620J	7801	“ “ “ Nut.....
27303	7801	“ Spring.....

BOBBIN WINDER

NO.	PLATE	NAME
27541	7800	Pulley.....
27330	7800	Spindle with 15072.....
27306	7800	Spool Pin.....
27307	7800	" Stand.....
27308	7800	Spool Stand complete, Nos. 418E, 1562J, 2106, 10141, 11241, 27306, 27307 and two each 2455 and wood screws 1 in. No. 10.....
11241	7800	Spool Washer (cloth).....
27331	7800	Stop Latch.....
35D	7801	" " Hinge Screw.....
2455	685	Tension Disc.....
1562J	693	" Regulating Thumb Nut.....
418E	693	" Screw Stud.....
10141	685	" Spring.....
2106	7801	" Thread Guide.....
27649	7800	Bobbin Winder, Nos. 35D, 1620J, 27303, 27330, 27331, 27527, 27540, 27541, 50356D and two wood screws 1 in. No. 7.....
27549	—	Bobbin Winder (swinging automatic, right hand) complete, Nos. 27308 and 27649

BOBBIN WINDER

(SWINGING AUTOMATIC, RIGHT HAND)

FOR FLAT OR ROUND BELT, FOR 14535

NO.	PLATE	NAME
41439	7804	Base with 458c, 27916 and two 28084....
41398	3583	Bobbin Carrier Key.....
27916	3583	Brake (leather).....
28084	3583	" Rivet.....
41440	3581	Frame.....
41441	3581	" Hinge Pin.....
458c	3583	" " " Set Screw.....
4784	3583	" Oil Pad.....
41442	3581	" Spring.....
41443	3581	Pulley with 155c.....
155c	3583	" Set Screw.....
41444	7804	Spindle with 41398.....
41445	7804	Stop Latch.....
41446	7804	" " Hinge Pin.....
2269	3583	" " Pin.....
41447	3581	Tripping Arm with 176D.....
176D	3583	" " Clamping Screw.....

BOBBIN WINDER

NO.	PLATE	NAME
41448	7804	Bobbin Winder, Nos. 2269, 41439 to 41447, two 4784 and three wood screws 1 in. No. 7.....

THREAD UNWINDER PARTS

27555	3582	Spool Pin.....
41450	3582	" Rest.....
41451	—	" " 41450 with 138B and 27555....
138B	3583	" " Set Screw.....
27557	3582	" Stand with 138B.....
41514	3582	" Weight, 4 in. diam., with 41515....
41515	3583	" " Centre Pin.....
2102	3583	Tension Disc.....
1560c	3583	" Regulating Thumb Nut.....
828c	7801	" Screw Stud.....
2103	3583	" Spring.....
5769	3583	" Thread Eyelet.....
17547	7801	" " Guard.....
60608	3582	Thread Guard.....
27560	3582	" " Rod, 26 in. long.....
138B	3583	" " " Set Screw.....
330D	3583	" " Set Screw.....
60609	—	Thread Guard complete, Nos. 330D, 828c, 1560c, 2103, 5769, 17547, 60608 and two 2102.....
41454	3582	Thread Unwinder complete, for one large spool, Nos. 27557, 27560, 41451, 41514, 60609 and three wood screws 1¼ in. No. 12.....
41449	—	Bobbin Winder (swinging automatic, right hand) complete, Nos. 41448 and 41454

KNEE LIFTER PARTS

(POWER TABLE)

NO.	PLATE	NAME
5871	3638	Bell Crank.....
13253	—	" " 5871 with 5599 and 5601....
5599	3638	" " Bracket.....
178E	691	" " Screw.....
5601	3641	" " Hinge Pin.....
5735	3641	" " Spring.....
5872	3638	Bell Crank complete, Nos. 5735 and 13253.....

KNEE LIFTER PARTS

NO.	PLATE	NAME
4724	3638	Lifting Lever with 448c.....
4728	3638	" " Connecting Rod.....
12416	3641	" " " " Joint.....
76D	691	" " " " " Hinge Screw.....
1521E	693	Lifting Lever Connecting Rod Lock Nut.
802D	691	" " Hinge Screw.....
4727	695	" " Pin.....
448c	691	" " " Set Screw.....
5772	3628	Rock Shaft.....
7539	3628	" " Hanger with two wood screws 1 in. No. 10.....
2765	3628	Rock Shaft Knee Arm.....
2768	—	Rock Shaft Knee Arm complete, Nos. 2765 to 2767.....
2766	3628	Rock Shaft Knee Arm Hub with 356c...
356c	693	" " " " " Set Screw...
2767	3628	" " " Plate with 356c.....
356c	693	" " " " Set Screw.....
6337	3628	" " Lifting Bracket with two 356c
12243	3628	" " " " Hook.....
356c	693	" " " " " Set Screw.....
356c	693	Rock Shaft Lifting Bracket Set Screw...
2770	3628	" " Stop Dog with 356c.....
356c	693	" " " " Set Screw.....
5773	3628	Rock Shaft complete, Nos. 2768, 2770, 5772, 6337, 12243 and two 7539.....
5874	—	Knee Lifter complete, Nos. 76D, 802D, 1521E, 4724, 4727, 4728, 5773, 5872, 12416 and two 178E.....

KNEE LIFTER PARTS

(STAND)

NO.	PLATE	NAME
5871	3638	Bell Crank.....
13253	—	" " 5871 with 5599 and 5601.....
5599	3638	" " Bracket.....
178E	691	" " " Screw.....
5601	3641	" " Hinge Pin.....
5735	3641	" " Spring.....
5872	3638	Bell Crank complete, Nos. 5735 and 13253
4724	3638	Lifting Lever with 448c.....
4728	3638	" " Connecting Rod.....

KNEE LIFTER PARTS

NO.	PLATE	NAME
12416	3641	Lifting Lever Connecting Rod Joint.....
76D	691	" " " " " Hinge Screw.....
1521E	693	Lifting Lever Connecting Rod Lock Nut.
802D	691	" " Hinge Screw.....
4727	695	" " Pin.....
448c	691	" " " Set Screw.....
5772	3628	Rock Shaft.....
7539	3628	" " Hanger with two wood screws 1 in. No. 10.....
2765	3628	Rock Shaft Knee Arm.....
2768	—	Rock Shaft Knee Arm complete, Nos. 2765 to 2767.....
2766	3628	Rock Shaft Knee Arm Hub with 356c...
356c	693	" " " " " Set Screw...
2767	3628	" " " Plate with 356c.....
356c	693	" " " " Set Screw.....
6337	3628	" " Lifting Bracket with two 356c
2778	3628	" " " " Hook.....
356c	693	" " " " " Set Screw.....
356c	693	Rock Shaft Lifting Bracket Set Screw...
2770	3628	" " Stop Dog with 356c.....
356c	693	" " " " Set Screw.....
5875	—	Rock Shaft complete, Nos. 2768, 2770, 2778, 5772, 6337 and two 7539.....
5877	—	Knee Lifter complete, Nos. 76D, 802D, 1521E, 4724, 4727, 4728, 5872, 5875, 12416 and two 178E.....

STAND

ROCKING TREADLE

NO.	PLATE	NAME
25133	7802	Band Wheel (two speed) 10 in. and 12 in. diam., with 2117 and 25010.....
25010	7802	Band Wheel Crank.....
2117	695	" " " Pin.....
297C	692	" " " Screw Centre.....
46629	—	" " " " " 297c with 1507R.....
1507R	693	Band Wheel Crank Screw Centre Nut...
25136	—	Belt, size $\frac{1}{8}$ in., length 62 $\frac{1}{2}$ in., with 25029
25029	695	" Hook.....
46667	—	Brace.....
82985	5216	" 46667 with three 46629.....

NO.	PLATE	NAME
46662	7803	Brace (sectional) complete, Nos. 46528, 46663 and three 880r.....
46528	7803	Brace Section (left) with 46629.....
46663	7803	" " (right) with two 46629....
880R	7801	" " Screw.....
748R	7801	" " Screw.....
82973	5216	Leg.....
25123	—	Pitman Adjusting Block.....
558R	693	" " Screw.....
1570R	693	" " " Nut.....
25075	695	" " " Washer.....
25074	7802	Pitman (adjustable) complete with two each 558R, 1570R, 25075 and 25123...
7958	695	Pitman Pin.....
11742	695	" Washer.....
25082	7802	Treadle.....
297C	692	" Screw Centre.....
46629	—	" " " 297c with 1507r....
1507R	693	" " " Nut.....
25086	7802	Wrench for 1507.....
25287	—	Stand (iron work) complete, Nos. 7958, 11742, 25074, 25082, 25086, 25133, 82985, two 82973 and four 748R.....

TRIMMINGS FOR END AND BACK LEAF TABLE

NO.	PLATE	NAME
25001	7802	Back Leaf Bracket with two wood screws 1 in. No. 10.....
25002	7802	Back Leaf Scroll Bracket with 3/4 in. No. 9 and two 1 in. No. 12 wood screws.....
25003	7802	Back Leaf Sliding Hinge, Nos. 25149, three 25151 and six wood screws 3/4 in. No. 8.....
25151	7802	Back Leaf Sliding Hinge Plate.....
25149	7802	" " " " Rod.....
25057	7802	End Leaf Support complete, Nos. 25143, 25168, 25169 and two wood screws 5/8 in No. 7.....
25168	—	End Leaf Support Bracket.....
25060	7802	" " " Button with wood screw 1 1/2 in. No. 12 R. H. B.....
25169	—	End Leaf Support Lever.....
25143	695	" " " " Hinge Pin.....
124535	—	Machine Cushion (rubber).....
124537	7808	" " " 124535 with 124536....
124536	—	" " " Tack.....

OBSOLETE PARTS

NO.	PLATE	NAME
566c	692	Crank Connecting Rod Hinge Screw, use 565c.....
5791	3629	Face Plate for 8174.....
8174	—	" " 5791 with 2105, for 8178.....
8178	—	Face Plate complete, Nos. 233D, 448c, 2108, 2127, 5797, 5989, 5991 and 8174, use 13256.....
2108	3636	Face Plate Thread Guard for 8178.....
5994	3639	Feed Bar.....
5995	3640	" Dog, for leather, 8 teeth.....
5855	3640	" " 8 teeth (10 teeth to the inch).....
5891	—	" " 11 teeth.....
5895	—	" " 19 teeth.....
5998	3639	" Lifting Rock Shaft Crank with 1813 and two 172E.....
5847	3639	Feed Lifting Rock Shaft Crank with 1813 and two 172E, use 8154.....
172E	691	Feed Lifting Rock Shaft Crank Clamping Screw.....
58E	691	Feed Regulator Hinge Screw.....
3041	—	Feed Rock Shaft complete, Nos. 3042 and 3043, use 56880.....
3043	3632	Feed Rock Shaft Crank with 462c, for 3041.....
462c	3632	Feed Rock Shaft Crank Set Screw for 3043.....
3130	3641	Guide Bar Driving Crank with 1862 and 3131.....
626c	693	Guide Bar Lifting Bracket Guide Screw Stud.....
3054	3639	Lifting Presser Bar.....
2359c	695	" " " Lifter.....
4855	3641	" " " ".....
3100	3630	" " " Spring, use 32675....
5792	3640	" " " Foot.....
8156	3640	" " ".....
*3098	3641	Needle Bar Connecting Link with 390E... 56847 " " " " 3098 with 15472.....
2305	695	Needle Bar Connecting Stud with 155c, use 15472.....
5834	3639	Oscillating Shaft.....
12093	685	Shuttle Cylinder.....
56514	—	" " 12093 with 773r and 12095.....
12095	685	Shuttle Tension Spring.....

OBSOLETE PARTS

NO.	PLATE	NAME
5751	685	Shuttle (cylinder) 2½ in. diam., complete, Nos. 8162, 12000, 14535 and 56514, use 8189.
8187	3634	Shuttle Cylinder for 8194.
8194	—	“ “ 8187 with 773F and 8188, for 8189.
12000	685	Shuttle Cylinder Hinge Pin for 8162.
13260	7808	“ “ “ “ 13265.
12001	685	“ “ Latch for 8162.
12002	685	“ “ “ Pin for 8162.
11854	3634	“ “ “ Spring for 8162.
590D	692	“ “ “ Screw for 8162.
8188	3634	Shuttle Tension Spring for 8194.
8189	3634	“ (cylinder) 2½ in. diam. complete, Nos. 8162, 8194, 12000 and 14535, use 13265.
5751	685	Shuttle (cylinder) 2½ in. diam., complete, Nos. 8162, 12000, 14535 and 56514, use 8189.
5938	3639	Shuttle Race Back.
741D	691	“ “ “ Spring Screw.
5755	3639	“ “ “ Body.
5760	3641	“ “ “ Cap (left).
5756	3641	“ “ “ (right).
5790	3641	“ “ “ Dowel Pin.
5754	—	Shuttle Race complete, Nos. 741D, 5755, 5756, 5760, 5938, 5939 and two each 219D, 5790 and 5965, use 5841.
129E	691	Shuttle Race Frame Clamping Screw.
145D	691	“ “ Screw.
240D	691	“ “ Slide Spring Screw.
2102	685	Tension Disc.
76C	691	Thread Take-up Lever Hinge Screw.
5889	—	Throat Plate for 5891 and 5895.
602D	691	Vibrating Presser Bar Hinge Cap Screw.
3135	3641	“ “ “ Lifting Bell Crank
602D	691	“ “ “ “ “ “
		Hinge Cap Screw.
5794	3640	Vibrating Presser Foot.

NUMERICAL LIST OF PARTS

NO.	PLATE	NAME
35D	7801	Bobbin Winder Stop Latch Hinge Screw for 27649.
46D	691	Bobbin Winder Frame Hinge Screw for 5762.
58E	691	Feed Regulator Hinge Screw, obsolete.
76D	691	Lifting Lever Connecting Rod Joint Hinge Screw for 5874 and 5877.
76C	691	Thread Take-up Lever Hinge Screw, obsolete.
123E	691	Arm Screw.
129E	691	Shuttle Race Frame Clamping Screw obsolete.
135D	691	Oil Cup Screw.
136F	691	Driving Flange Latch Hinge Screw for 5993.
138B	3583	Thread Unwinder Spool Rest Set Screw for 41451.
138B	3583	Thread Unwinder Thread Guard Rod Set Screw for 27557.
141D	3636	Shuttle Race Screw.
144D	691	Arm Shaft Screw.
145D	691	Shuttle Race Screw, obsolete.
155C	691	Needle Bar Connecting Stud Set Screw for 2305 and 15472.
155C	3583	Bobbin Winder Pulley Set Screw for 41443.
157E	691	Feed Lifting Rock Shaft Crank Fork Clamping Screw for 5997.
157J	691	Feed Rock Shaft Crank Set Screw for 29633.
158E	691	Crank Connecting Rod Cap Screw for 5969.
159D	691	Bobbin Winder Bracket Screw.
172E	691	Feed Lifting Rock Shaft Crank Clamping Screw for 5847 and 5998, obsolete.
175D	691	Face Plate Screw.
176D	3583	Bobbin Winder Tripping Arm Clamping Screw for 41447.
178E	691	Bell Crank Bracket Screw for 5874 and 5877.
181D	5830	Binder Edge Guide Screw for 120061.
190D	691	Bobbin Winder Spring Screw for 5762.
190D	691	Corder Cord Guide Screw for 28329 and 120207.
190D	691	Oscillating Shaft Crank Roller Cap Screw for 1885.
191C	691	Feed Dog Screw.
193D	691	Lifting Presser Foot Screw.

NUMERICAL LIST OF PARTS

NO.	PLATE	NAME
196F	3632	Needle Clamp Screw for 4265.....
211D	692	Oil Cup Pad Screw for 5781.....
217F	691	Vibrating Presser Foot Screw.....
219D	691	Shuttle Race Cap Screw (large) for 5754 and 8193.....
229D	7808	Shuttle Cylinder Latch Screw for 13263..
233D	691	Face Plate Thread Guard Screw for 13256
233D	691	Thread Take-up Spring Regulator Plate Screw for 8178.....
240D	691	Shuttle Race Slide Spring Screw, obsolete
262J	692	Pressure Regulating Thumb Screw.....
286D	692	Arm Side Cover Thumb Screw.....
286D	692	Binder Guide Thumb Screw for 36344, 120061, 120247 and 120248.....
297C	692	Band Wheel Crank Screw Centre for 46629
297C	692	Treadle Screw Centre for 46629.....
304C	692	Feed Rock Shaft Screw Centre.....
313C	692	" Bar Screw Centre.....
330D	692	Driving Flange Latch Spring Screw for 5993.....
330D	3583	Thread Unwinder Thread Guard Set Screw for 60609.....
333D	692	Bobbin Winder Friction Wheel Washer Screw for 5809.....
337D	692	Vibrating Presser Bar Spring Screw for 56844.....
356C	693	Rock Shaft Knee Arm Hub Set Screw for 2766.....
356C	693	Rock Shaft Knee Plate Set Screw for 2767
356C	693	" " Lifting Bracket Hook Set Screw for 6337.....
356C	693	Rock Shaft Lifting Bracket Set Screw for 6337.....
356C	693	Rock Shaft Stop Dog Set Screw for 2770
375C	692	Feed Connecting Link Hinge Screw.....
375C	692	" Forked Connection Hinge Screw...
390E	692	Needle Bar Connecting Link Adjusting Screw for 3098 and 4898.....
401E	7801	Throat Plate Needle Hole Strip Screw for 5867, 5381 and 8199.....
404D	692	Guide Bar Lifting Bracket Screw for 4730
418E	693	Bobbin Winder Tension Screw Stud for 27308.....
418D	693	Thread Retainer Screw Stud for 5989....
435C	691	Driving Flange Set Screw for 5978.....
446C	691	Feed Cam Set Screw for 3032.....
446C	691	Thread Take-up Cam Set Screw for 5793
448C	691	Arm Shaft Bushing (back) Set Screw....

NUMERICAL LIST OF PARTS

NO.	PLATE	NAME
448C	691	Balance Wheel Set Screw for 3011.....
448C	691	Lifting Lever Pin Set Screw for 4724....
448C	691	Tension Stud Set Screw for 8178.....
453C	692	Oscillating Shaft Collar Set Screw for 5917
453C	692	" " Crank Set Screw for 6000
457C	7798	Corder Cord Guide Bed Leveling Screw for 120206.....
458C	3583	Bobbin Winder Frame Hinge Pin Set Screw for 41439.....
462C	3632	Feed Rock Shaft Crank Set Screw for 3043, obsolete.....
558R	693	Pitman Adjusting Screw for 25074.....
565C	7808	Crank Connecting Rod Hinge Screw....
566C	692	Crank Connecting Rod Hinge Screw, obsolete, use 565c.....
575E	3636	Shuttle Race Frame Clamping Screw....
590D	692	" Cylinder Latch Spring Screw for 8162, obsolete.....
598C	691	Lifting Presser Bar Lifter Screw.....
602D	691	Vibrating Presser Bar Hinge Cap Screw, obsolete.....
602D	691	Vibrating Presser Bar Lifting Bell Crank Hinge Cap Screw, obsolete.....
626C	693	Guide Bar Lifting Bracket Guide Screw Stud, obsolete.....
635C	692	Oscillating Rock Shaft Hinge Pin Screw Bearing for 8163.....
641E	691	Lifting Presser Bar Bracket Clamping Screw for 3133.....
651D	692	Needle Clamp Thread Guide Screw for 4865.....
671D	5807	Binder Edge Guide Thumb Screw for 36344.....
690E	691	Guide Bar Driving Crank Wedge Adjust- ing Screw.....
725E	3636	Shuttle Race Slide Spring Screw for 5946.
741D	691	" " Back Spring Screw for 5754, obsolete.....
742F	692	Throat Plate Screw.....
747D	3641	Guide Thumb Screw.....
748R	7801	Brace Screw for 25287.....
773F	692	Shuttle Tension Regulating Screw for 8194, 13259 and 56514.....
802D	691	Lifting Lever Hinge Screw for 5874 and 5877.....
810D	3633	Vibrating Presser Bar Hinge Cap Screw for 4730.....

NUMERICAL LIST OF PARTS

NO.	PLATE	NAME
810E	3633	Vibrating Presser Bar Lifting Bell Crank Cap Screw for 4730.
817C	693	Tension Stud for 5797.
818D	692	Feed Regulator Thumb Screw.
828C	7801	Thread Unwinder Tension Screw Stud for 60609.
880R	7801	Brace Section Screw for 46662.
933D	3634	Shuttle Race Back Spring Screw for 5841.
934J	3636	" " Cap Screw (small) for 8193.
1036C	7790	Binder Leveling Screw for 120242.
1036C	7790	" " " (back) for 36340.
1044D	7798	Corder Cord Guide Arm Hinge Screw for 28329 and 120207.
1054C	3632	Oscillating Shaft Crank Roller Screw Stud for 1885.
1088C	3636	Thread Take-up Lever Hinge Screw for 8159.
1128E	3632	Feed Regulator Hinge Screw.
1186E	3636	" Lifting Rock Shaft Crank Clamping Screw for 8154.
1266C	7801	Binder Leveling Screw (front) for 36340.
1507B	693	Band Wheel Crank Screw Centre Nut for 46629.
1507R	693	Treadle Screw Centre Nut for 46629.
1513J	693	Crank Connecting Rod Hinge Screw Nut
1513J	693	Feed Rock Shaft Screw Centre Nut.
1513J	693	Oscillating Rock Shaft Hinge Pin Nut for 56812.
1513J	693	Oscillating Rock Shaft Hinge Pin Screw Bearing Nut for 8163.
1513J	693	Oscillating Shaft Crank Roller Screw Stud Nut for 6000.
1518E	693	Feed Connecting Link Hinge Screw Nut
1518E	693	" Forked Connection Hinge Screw Nut
1519J	693	" Bar Screw Centre Nut.
1521E	693	Lifting Lever Connecting Rod Lock Nut for 5874 and 5877.
1560C	693	Tension Regulating Thumb Nut for 5797
1560C	3583	Thread Unwinder Tension Regulating Thumb Nut for 60609.
1562J	693	Bobbin Winder Tension Regulating Thumb Nut for 27308.
1562J	693	Thread Retainer Regulating Thumb Nut for 5989.
1570R	693	Pitman Adjusting Screw Nut for 25074.
1620J	7801	Bobbin Winder Frame Hinge Screw Nut for 27649.

NUMERICAL LIST OF PARTS

NO.	PLATE	NAME
1813	693	Feed Lifting Rock Shaft Crank Roller and Stud for 5847, 5998 and 8154.
1819	693	Thread Take-up Lever Roller and Stud for 5758.
1823	693	Lifting Presser Bar Bracket Roller and Stud for 3133.
1862	3633	Guide Bar Driving Crank Roller for 3130 and 4854.
1885	693	Oscillating Shaft Crank Roller with 190b, 1054c and 5968, for 6000.
2002	3636	Arm Dowel Pin.
2022	3634	Shuttle Driver Pin.
2049	3632	Feed Rock Shaft Crank Pin.
2049	3632	Oscillating Shaft Crank Pin.
2058	3630	Lifting Presser Bar.
2070	3632	" " " Spring Washer.
2102	685	Tension Disc, obsolete.
2102	3583	Thread Unwinder Tension Disc for 60609
2103	685	Tension Spring for 5797.
2103	3583	Thread Unwinder Tension Spring for 60609.
2105	3636	Tension Thread Guard for 8174 and 13255
2106	7801	Bobbin Winder Tension Thread Guide for 27308.
2108	3636	Face Plate Thread Guard for 8178, obsolete.
2117	695	Band Wheel Crank Pin for 25133.
2127	3636	Thread Take-up Spring Regulator Plate for 8178 and 13256.
2269	3583	Bobbin Winder Stop Latch Pin for 41448
2305	695	Needle Bar Connecting Stud with 155c, obsolete, use 15472.
2359C	695	Lifting Presser Bar Lifter, obsolete.
2361	3633	Vibrating Presser Bar Hinge Bracket for 56752.
2362	3633	Vibrating Presser Bar Hinge Bracket Rivet for 56752.
2455	685	Bobbin Winder Tension Disc for 27308.
2455	685	Thread Retainer Disc for 5989. Nos. 2765 to 2767 for 2768
2765	3628	Rock Shaft Knee Arm.
2766	3628	" " " " Hub with 356c.
2767	3628	" " " " Plate with 356c.
2768	—	Rock Shaft Knee Arm complete for 5773 and 5875, Nos. 2765 to 2767.
2770	3628	Rock Shaft Stop Dog with 356c, for 5773 and 5875.
2778	3628	Rock Shaft Lifting Bracket Hook for 5875

NO.	PLATE	NAME
3005	3629	Arm Shaft Bushing (back).....
3011	3628	Balance Wheel (two speed) 3 in. and 5 in. pulleys with two 448c.....
3012	3636	Thread Take-up Cam Pin.....
3016	3630	Bed Hinge complete for 5992, Nos. 3017, 3018 and 3020.....
3017	—	Bed Hinge (half butt) for 5992, for 3016.
3018	—	“ “ “ “ “ wood table, for 3016.....
3020	3641	Bed Hinge Pin for 3016.....
3021	3636	“ “ Rivet for 5992.....
3032	3629	Feed Cam with 446c, for 13257.....
3033	3632	“ Connecting Link.....
3037	3629	“ Forked Connection.....
3039	3632	“ Regulator.....
3041	—	Feed Rock Shaft complete, Nos. 3042 and 3043, obsolete, use 56880.....
3042	3628	Feed Rock Shaft for 3041 and 56880.....
3043	3632	“ “ “ Crank with 462c, for 3041, obsolete.....
3052	3629	Oscillating Rock Shaft Hinge Pin for 56812.....
3054	3639	Lifting Presser Bar, obsolete.....
3094	3633	Guide Bar Driving Crank Wedge.....
*3098	3641	Needle Bar Connecting Link with 390E, for 56847, obsolete.....
3100	3630	Lifting Presser Bar Spring, obsolete, use 32675.....
3126	3633	Guide Bar for 56752.....
3130	3641	“ “ Driving Crank with 1862 and 3131, obsolete.....
3131	3633	Guide Bar Driving Crank Roller Cap for 3130 and 4854.....
3133	3632	Lifting Presser Bar Bracket with 641E and 1823.....
3134	3633	Vibrating Presser Bar for 4730.....
3135	3641	“ “ “ Lifting Bell Crank, obsolete.....
3137	3633	Vibrating Presser Bar Spring for 56844.....
4264	3630	Needle Bar.....
4265	—	“ Clamp with 196F, for 4865.....
4266	3632	“ “ Thread Guide for 4865.....
4288	3629	Arm Side Cover.....
4347	3637	Wrench for 1513 and 1518 (Accessories).....
*4349	—	Crank Connecting Rod Cap for 5969.....
4448	695	Arm Oil Tube, for intermediate bearing, for 5801.....
*4449	—	Arm Shaft Bushing (front) for 5801.....
4723	3633	Guide Bar Lifting Bracket for 4730.....

NO.	PLATE	NAME
4724	3638	Lifting Lever with 448c, for 5874 and 5877.....
4725	695	Lifting Presser Bar Lifting Bracket.....
4726	695	“ “ “ “ Guide Pin.....
4727	695	Lifting Lever Pin for 5874 and 5877.....
4728	3638	“ “ Connecting Rod for 5874 and 5877.....
4730	—	Guide Bar complete, Nos. 810D, 810E, 3134, 4723, 4897, 56844 and three 404D.....
4784	3583	Bobbin Winder Frame Oil Pad for 41448.....
4854	3633	Guide Bar Driving Crank with 1862 and 3131.....
4855	3641	Lifting Presser Bar Lifter, obsolete.....
4865	3632	Needle Clamp complete, Nos. 651D, 4265 and 4266.....
4897	3633	Vibrating Presser Bar Lifting Bell Crank for 4730.....
*4898	3633	Needle Bar Connecting Link with 390E, for 56764.....
5599	3638	Bell Crank Bracket for 13253.....
5601	3641	“ “ Hinge Pin for 13253.....
5735	3641	“ “ Spring for 5872.....
5751	685	Shuttle (cylinder) 2½ in. diam., complete, Nos. 8162, 12000, 14535 and 56514, obsolete, use 8189.....
5752	685	Shuttle Frame for 8162.....
5754	—	Shuttle Race complete, Nos. 741D, 5755, 5756, 5760, 5938, 5939 and two each 219D, 5790 and 5965, obsolete, use 5841.....
5755	3639	Shuttle Race Body for 5754, obsolete.....
5756	3641	“ “ Cap (right) for 5754, obsolete.....
*5758	3635	Thread Take-up Lever with 1819, for 8159.....
5759	3640	Throat Plate for 5855, 5995 and 13252.....
5760	3641	Shuttle Race Cap (left) for 5754, obsolete.....
5761	3638	Bobbin Winder Spindle for 5809.....
5762	3638	Bobbin Winder complete, Nos. 46D, 190D, 5809, 5958 and 11114.....
5769	3583	Thread Unwinder Tension Thread Eyelet for 60609.....
5772	3628	Rock Shaft for 5773 and 5875.....
5773	3628	Rock Shaft complete for 5874, Nos. 2768, 2770, 5772, 6337, 12243 and two 7539... Nos. 5778 to 5780 FOR 5781.....
5778	3629	Oil Cup.....
5779	695	“ “ Pad (felt).....
5780	695	“ “ Thread Eyelet.....

NUMERICAL LIST OF PARTS

NO.	PLATE	NAME
5781	—	Oil Cup complete, Nos. 211D, 5778 to 5780 and 7071.....
5790	3641	Shuttle Race Cap Dowel Pin for 5754, obsolete.....
5791	3629	Face Plate for 8174, obsolete.....
5792	3640	Lifting Presser Foot, obsolete.....
5793	3635	Thread Take-up Cam 8184 with 446c....
5794	3640	Vibrating Presser Foot, obsolete.....
5795	3636	Tension Wheel with 5796, for 5797.....
*5796	—	“ “ Flange for 5795.....
5797	—	Tension complete (wheel) for 8178 and 13256, Nos. 817c, 1560c, 2103, 5795 and two each 5983 and 5984.....
*5801	—	Arm with 4448 and 4449.....
5804	3624	Throat Plate for 5856, for 35145.....
5809	—	Bobbin Winder Frame complete for 5762, Nos. 333D, 5761, 5959 to 5961 and 5963.....
5811	695	Arm Spool Pin and Thread Eyelet.....
5814	3624	Vibrating Presser Foot for 5840 and 35145.....
5816	3631	Lifting Presser Foot.....
5833	3634	Shuttle Driver.....
5834	3639	Oscillating Shaft, obsolete.....
5839	3630	Feed Bar.....
5840	3647	Feed Dog, 12 teeth, for canvas work.....
5841	—	Shuttle Race complete, Nos. 933D, 5848, 5939 and 8193.....
Nos. 5842 to 5845 for 8193		
5842	3634	Shuttle Race Back Spring Rest Pin.....
5843	3635	“ “ Body.....
5844	3636	“ “ Cap (left).....
5845	3636	“ “ “ (right).....
5847	3639	Feed Lifting Rock Shaft Crank with 1813 and two 172E, obsolete, use 8154.....
5848	3635	Shuttle Race Back for 5841.....
5853	—	Throat Plate Needle Hole Strip for 5881.....
5855	3640	Feed Dog, 8 teeth (10 teeth to the inch) obsolete.....
5856	3624	Feed Dog for 35145.....
5862	3618	Throat Plate for 5899.....
5865	—	“ “ Body for 5867.....
5866	3618	“ “ Needle Hole Strip for 5867.....
5867	3618	Throat Plate complete for 8153, Nos. 5865, 5866 and two 401E.....
5871	3638	Bell Crank for 13253.....
5872	3638	Bell Crank complete for 5874 and 5877, Nos. 5735 and 13253.....

NUMERICAL LIST OF PARTS

NO.	PLATE	NAME
5874	—	Knee Lifter complete (power table) Nos. 76D, 802D, 1521E, 4724, 4727, 4728, 5773, 5872, 12416 and two 178E.....
5875	—	Rock Shaft complete, for 5877, Nos. 2768, 2770, 2778, 5772, 6337 and two 7539..
5877	—	Knee Lifter complete (stand) Nos. 76D, 802D, 1521E, 4724, 4727, 4728, 5872, 5875, 12416 and two 178E.....
5880	—	Throat Plate Body for 5881.....
5881	3647	Throat Plate complete for 5840, Nos. 5853, 5880 and two 401E.....
5889	—	Throat Plate for 5891 and 5895, obsolete.....
5890	3631	Vibrating Presser Foot.....
5891	—	Feed Dog, 11 teeth, obsolete.....
5895	—	“ “ 19 teeth, obsolete.....
5899	3618	Feed Dog.....
5917	3634	Oscillating Shaft Collar with 453c.....
5938	3639	Shuttle Race Back for 5754, obsolete....
5939	3635	“ “ “ Spring for 5754 and 5841.....
5943	3635	Shuttle Race Frame with 5944.....
5944	3636	“ “ “ Steady Pin for 5943.....
5945	—	“ “ Slide for 5946.....
5946	3635	Shuttle Race Slide complete, Nos. 5945, 5947 and two 725E.....
5947	3635	Shuttle Race Slide Spring for 5946.....
5958	3638	Bobbin Winder Bracket for 5762.....
Nos. 5959 to 5961 for 5809		
5959	3638	Bobbin Winder Frame.....
5960	3638	“ “ Friction Wheel (leather).....
5961	3638	“ “ “ “ Washer..
5963	3638	“ “ Spindle Flange for 5809..
5965	3634	Shuttle Race Back Steady Pin for 5754 and 8193.....
5968	3632	Oscillating Shaft Crank Roller Cap Screw Washer for 1885.....
5969	3630	Crank Connecting Rod with 4349 and two 158E.....
*5970	3629	Oscillating Rock Shaft with 11165, for 8163.....
5975	3627	Drip Pan (stand) with four wood screws $\frac{3}{8}$ in. No. 5.....
5976	—	Drip Pan (power table) with four wood screws $\frac{3}{8}$ in. No. 5.....
5977	3628	Balance Wheel (two speed) for 5981.....

NUMERICAL LIST OF PARTS

NO.	PLATE	NAME
		Nos. 5978 TO 5980 FOR 5993
5978	3635	Driving Flange with two 435c.....
5979	3632	" " Latch.....
5980	3632	" " " Spring.....
5981	—	Loose Wheel Attachment complete, Nos. 5977 and 5993.....
5983	3636	Tension Washer (felt) for 5797.....
5984	3636	" " (steel) for 5797.....
5989	—	Thread Retainer complete for 8178 and 13256, Nos. 418d, 1562r, 10141 and two 2455.....
5991	3636	Thread Take-up Spring for 8178 and 13256
*5992	—	Bed with two 3016 and six 3021.....
5993	—	Driving Flange complete for 5981, Nos. 136r, 330b and 5978 to 5980.....
5994	3639	Feed Bar, obsolete.....
5995	3640	" Dog, for leather, 8 teeth, obsolete..
5996	3630	" Lifting Rock Shaft.....
5997	3630	Feed Lifting Rock Shaft Crank Fork with 157E.....
5998	3639	Feed Lifting Rock Shaft Crank with 1813 and two 172E, obsolete.....
5999	—	Oscillating Shaft Crank for 6000.....
6000	3632	Oscillating Shaft Crank complete, Nos. 453c, 1513r, 1885 and 5999.....
6037	7798	Corder Cord Guide Bracket Rivet for 26796.....
6178	3628	Arm Shaft for 3011.....
6179	3628	" " " 5977, for 13257.....
6337	3628	Rock Shaft Lifting Bracket with two 356c for 5773 and 5875.....
7071	695	Oil Cup Pad Screw Washer for 5781.....
7539	3628	Rock Shaft Hanger with two wood screws 1 in. No. 10, for 5773 and 5875.....
7958	695	Pitman Pin for 25287.....
8153	7796	Feed Dog.....
8154	3630	Feed Lifting Rock Shaft Crank with 1813 and two 1186E.....
8156	3640	Lifting Presser Foot, obsolete.....
8159	—	Thread Take-up Lever 5758 with 1088c
8162	—	Shuttle Frame 5752 with 590d, 11854, 12001 and 12002, for 8189.....
8163	—	Oscillating Rock Shaft 5970 with 635c, 1513r and 56812.....
8166	3630	Oscillating Shaft.....
8174	—	Face Plate 5791 with 2105, for 8178, obsolete.....

NUMERICAL LIST OF PARTS

NO.	PLATE	NAME
8178	—	Face Plate complete, Nos. 233d, 448c, 2108, 2127, 5797, 5989, 5991 and 8174, obsolete, use 13256.....
*8184	—	Thread Take-up Cam for 5793, for 13257
8187	3634	Shuttle Cylinder for 8194, obsolete.....
8188	3634	" Tension Spring for 8194, obsolete
8189	3634	Shuttle (cylinder) 2½ in. diam., complete, Nos. 8162, 8194, 12000 and 14535, obsolete, use 13265.....
8190	3631	Feed Dog.....
8191	3631	Lifting Presser Bar Lifter.....
8192	3631	Throat Plate for 8190.....
8193	—	Shuttle Race Body 5843 with 5842, 5844, 5845 and two each 219d, 934j and 5965, for 5841.....
8194	—	Shuttle Cylinder 8187 with 773F and 8188, for 8189, obsolete.....
8196	3647	Feed Dog.....
8197	—	Throat Plate Body for 8199.....
8198	3647	" " Needle Hole Strip for 8199
8199	3647	Throat Plate complete for 8196, Nos. 8197, 8198 and two 401F.....
8879	7801	Arm Spool Pin Washer (cloth).....
10141	685	Bobbin Winder Tension Spring for 27308
10141	685	Thread Retainer Spring for 5989.....
11114	3638	Bobbin Winder Spring for 5762.....
11165	695	Oscillating Rock Shaft Oil Pad for 5970
11241	7800	Bobbin Winder Spool Washer (cloth) for 27308.....
11742	695	Pitman Washer for 25287.....
11854	3634	Shuttle Cylinder Latch Spring for 8162..
12000	685	" " Hinge Pin for 5751 and 8189, obsolete.....
12001	685	Shuttle Cylinder Latch for 8162, obsolete
12002	685	" " " Pin for 8162, ob- solete.....
12093	685	Shuttle Cylinder for 56514, obsolete....
12095	685	" Tension Spring for 56514, obsolete
12243	3628	Rock Shaft Lifting Bracket Hook for 5773
12296	3636	Thread Eyelet (side of arm).....
12416	3641	Lifting Lever Connecting Rod Joint for 5874 and 5877.....
13252	3647	Feed Dog, 14 teeth (18 teeth to the inch)
13253	—	Bell Crank 5871 with 5599 and 5601, for 5872.....
13254	7807	Face Plate for 13255.....
13255	—	" " 13254 with 2105, for 13256...

NO.	PLATE	NAME
13256	—	Face Plate complete, Nos. 448c, 2127, 5797, 5989, 5991, 13255, 56870 and two 233d.....
*13257	—	Arm Shaft 6179 with 3032 and 8184.....
13258	7809	Shuttle Cylinder for 13259.....
13259	—	“ “ 13258 with 773r and 13264, for 13265.....
13260	7808	Shuttle Cylinder Hinge Pin for 13265, obsolete.....
13261	7808	Shuttle Cylinder Latch for 13263.....
13262	7809	“ Frame for 13263.....
13263	—	“ “ 13262 with 229d and 13261, for 13265.....
13264	7808	Shuttle Tension Spring for 13259.....
13265	7809	Shuttle (cylinder) 2½ in. diam., complete, Nos. 13259, 13263, 13266 and 14535...
13266	7808	Shuttle Cylinder Hinge Pin for 13265.....
14535	685	Shuttle Bobbin for 5751, 8189 and 13265
15072	7801	Bobbin Winder Bobbin Position Pin for 27330.....
15472	3633	Needle Bar Connecting Stud with 155c, for 56764 and 56847.....
17547	7801	Thread Unwinder Tension Thread Guard for 60609.....
25001	7802	Back Leaf Bracket with two wood screws 1 in. No. 10 (Trimnings for End and Back Leaf Table).....
25002	7802	Back Leaf Scroll Bracket with ¾ in. No. 9 and two 1 in. No. 12 wood screws (Trimnings for End and Back Leaf Table).....
25003	7802	Back Leaf Sliding Hinge, Nos. 25149, three 25151 and six wood screws ¾ in. No. 8 (Trimnings for End and Back Leaf Table).....
25010	7802	Band Wheel Crank for 25133.....
25029	695	Belt Hook for 25136.....
25057	7802	End Leaf Support complete, Nos. 25143, 25168, 25169 and two wood screws ¾ in. No. 7 (Trimnings for End and Back Leaf Table).....
25060	7802	End Leaf Support Button with wood screw 1½ in. No. 12 R. H. B. (Trimnings for End and Back Leaf Table)...
25074	7802	Pitman (adjustable) complete, with two each 558r, 1570r, 25075 and 25123, for 25287.....
25075	695	Pitman Adjusting Screw Washer for 25074

NO.	PLATE	NAME
25082	7802	Treadle for 25287.....
25086	7802	Wrench for 1507 and 1510, for 25287....
25123	—	Pitman Adjusting Block for 25074.....
25133	7802	Band Wheel (two speed) 10 in. and 12 in. diam., with 2117 and 25010, for 25287
25136	—	Belt, size ⅝ in., length 62½ in., with 25029, for 25287.....
25143	695	End Leaf Support Lever Hinge Pin for 25057.....
25149	7802	Back Leaf Sliding Hinge Rod for 25003..
25151	7802	“ “ “ Plate for 25003.
25168	—	End Leaf Support Bracket for 25057.....
25169	—	“ “ “ Lever for 25057.....
25287	—	Stand (iron work) rocking treadle, complete, Nos. 7958, 11742, 25074, 25082, 25086, 25133, 82985, two 82973 and four 748a.....
25868	3637	Guide.....
26026	3637	Screw Driver, large (Accessories).....
26485	3637	Screw Driver, small (Accessories).....
26795	7798	Corder Cord Guide for 28329 and 120207
26796	7798	“ “ “ Arm with 26798 and three 6037, for 28329 and 120207.....
26798	7798	Corder Cord Guide Bracket for 26796....
26800	7797	Piping Attachment on Shank.....
26996	7796	Lifting Presser Foot with stitch set.....
27056	3637	Machine Button with wood screw 1¾ in. No. 14 R. H. B. (Accessories).....
27303	7801	Bobbin Winder Frame Spring for 27649..
27306	7800	“ “ Spool Pin for 27308.....
27307	7800	“ “ “ Stand for 27308...
27308	7800	Bobbin Winder Spool Stand complete for 27549, Nos. 418e, 1562r, 2106, 10141, 11241, 27306, 27307 and two each 2455 and wood screws 1 in. No. 10.....
27330	7800	Bobbin Winder Spindle with 15072, for 27649.....
27331	7800	Bobbin Winder Stop Latch for 27649....
27527	7800	“ “ Frame for 27649.....
27540	7800	“ “ Base for 27649.....
27541	7800	“ “ Pulley for 27649.....
27549	—	Bobbin Winder (swinging automatic, right hand) complete for 14535, Nos. 27308 and 27649.....
27555	3582	Thread Unwinder Spool Pin for 41451...
27557	3582	“ “ “ Stand with 138b, for 41454.....

NUMERICAL LIST OF PARTS

NO.	PLATE	NAME
27560	3582	Thread Unwinder Thread Guard Rod, 26 in. long, for 41454.....
27649	7800	Bobbin Winder for 27549, Nos. 35b, 1620j, 27303, 27330, 27331, 27527, 27540, 27541, 50356b and two wood screws 1 in. No. 7.....
27916	3583	Bobbin Winder Brake (leather) for 41439
28084	3583	" " " Rivet for 41439...
28306	7797	Vibrating Presser Foot for 28307.....
28307	7797	Binder on Shank.....
28314	3603	Lifting Presser Foot, for covering cord with thin leather.....
28315	3603	Vibrating Presser Foot for covering cord with thin leather.....
28317	3603	Throat Plate (grooved) for 35291, for covering cord with thin leather.....
28323	7796	Lifting Presser Foot with teeth on bottom of bend of toe part.....
28324	7796	Vibrating Presser Foot with teeth on bottom of bend of forked part.....
28325	3608	Lifting Presser Foot for 28329.....
28326	3608	Vibrating Presser Foot for 28329.....
28328	3608	Corder Cord Guide Bed for 28329.....
28329	3608	Corder (adjustable) complete, for buggy cushions, Nos. 190b, 1044b, 26795, 26796 and 28328.....
28333	7799	Hemmer on Shank.....
28894	3612	Binder on Shank, for carpets.....
29633	—	Feed Rock Shaft Crank with 157j, for 56880.....
32675	7808	Lifting Presser Bar Spring.....
35144	3624	Binder on Shank for 35145.....
35145	—	Binder complete, for patent leather or drill strip, to turn top edge under, for carpets, Nos. 5804, 5814, 5816, 5856 and 35144.....
35291	3603	Feed Dog (grooved) for covering cord with thin leather.....
35364	7796	Lifting Presser Foot for 120061, 120247 and 120248.....
35365	7796	Vibrating Presser Foot for 120061, 120247 and 120248.....
36013	5708	Hemmer on Shank, for ¼ in. to ½ in. hem, for canvas.....
36014	—	Hemmer on Shank, for ⅝ in. to 2 in. hem, for canvas.....
36015	5708	Feed Dog for 36013 and 36014.....
36016	5708	" " " 36015.....

NUMERICAL LIST OF PARTS

NO.	PLATE	NAME
36111	7797	Piping Attachment.....
36340	5807	Binder Bed with two each 1036c and 1266c, for 36344 and 120061.....
36341	5807	Binder Edge Guide for 36344.....
36342	5807	" Guide (lower) for 36344.....
36343	5807	" " (upper) for 36344.....
36344	5807	Binder (adjustable) complete, for leather binding, for canvas bags, leggings, etc., Nos. 286b, 671b and 36340 to 36343....
36345	7796	Lifting Presser Foot for 36344.....
36346	7796	Vibrating Presser Foot for 36344.....
41398	3583	Bobbin Winder Bobbin Carrier Key for 41444.....
41400	3637	Machine Rest Pin, wood (Accessories) Nos. 41439 to 41447 FOR 41448
44439	7804	Bobbin Winder Base with 458c, 27916 and two 28084.....
41440	3581	Bobbin Winder Frame.....
41441	3581	" " " Hinge Pin.....
41442	3581	Bobbin Winder Frame Spring.....
41443	3581	" " Pulley with 155c.....
41444	7804	" " Spindle with 41398.....
41445	7804	" " Stop Latch.....
41446	7804	" " " " Hinge Pin...
41447	3581	" " Tripping Arm with 176b.
41448	7804	" " for 41449, Nos. 2269, 41439 to 41447, two 4784 and three wood screws 1 in. No. 7.....
41449	—	Bobbin Winder (swinging automatic, right hand) complete, for 14535, Nos. 41448 and 41454.....
41450	3582	Thread Unwinder Spool Rest for 41451..
41451	—	" " " " 41450 with 138b and 27555, for 41454.....
41454	3582	Thread Unwinder complete, for one large spool, for 41449, Nos. 27557, 27560, 41451, 41514, 60609 and three wood screws 1¼ in. No. 12.....
41514	3582	Thread Unwinder Spool Weight, 4 in. diam., with 41515, for 41454.....
41515	3583	Thread Unwinder Spool Weight Centre Pin for 41514.....
41544	5830	Binder Edge Guide Screw Washer for 120061.....
46528	7803	Brace Section (left) with 46629, for 46662
46629	—	Band Wheel Crank Screw Centre 297c with 1507j, for 46663 and 82985.....

NUMERICAL LIST OF PARTS

NO.	PLATE	NAME
46629	—	Treadle Screw Centre 297c with 1507r, for 46528, 46663 and 82985.....
46662	7803	Brace (sectional) complete for 25287, Nos. 46528, 46663 and three 880r.....
46663	7803	Brace Section (right) with two 46629, for 46662.....
46667	—	Brace for 82985.....
50356D	7801	Bobbin Winder Frame Hinge Screw for 27649.....
56514	—	Shuttle Cylinder 12093 with 773F and 12095, for 5751, obsolete.....
56752	—	Guide Bar 3126 with 2361 and two 2362, for 56844.....
56764	—	Needle Bar Connecting Link 4898 with 15472.....
56812	—	Oscillating Rock Shaft Hinge Pin 3052 with 1513r, for 8163.....
56844	—	Guide Bar 56752 with 337D and 3137, for 4730.....
56847	—	Needle Bar Connecting Link 3098 with 15472, obsolete.....
56870	7808	Face Plate Thread Guard for 13256.....
56880	—	Feed Rock Shaft complete, Nos. 3042 and 29633.....
60608	3582	Thread Unwinder Thread Guard for 60609
60609	—	Thread Unwinder Thread Guard complete for 41454, Nos. 330D, 828c, 1560c, 2103, 5769, 17547, 60608 and two 2102.....
82973	5216	Leg for 25287.....
82985	5216	Brace 46667 with three 46629, for 25287. Nos. 120058 to 120060 for 120061
120058	5830	Binder Edge Guide.....
120059	5830	" Guide (lower).....
120060	5830	" " (upper).....
120061	5830	Binder (adjustable) complete, for ½ in. to 1½ in. leather binding, for short curves, Nos. 181D, 286D, 36340, 41544 and 120058 to 120060.....
120099	7797	Lifting Presser Foot for 26800.....
120100	7797	Vibrating Presser Foot for 26800.....
120206	7798	Corder Cord Guide Bed with 457c, for 120207.....
120207	7798	Corder (adjustable) complete, for short turns on cushions, Nos. 190D, 1044D, 26795, 26796 and 120206.....
120242	7790	Binder Bed with 1036c, for 120247 and 120248.....

NUMERICAL LIST OF PARTS

NO.	PLATE	NAME
120243	7791	Binder Folder (lower) for 120248.....
120244	7790	" " (upper) for 120247 and 120248.....
120245	7790	Binder Guide (centre) for 120247 and 120248.....
120246	7790	Binder Guide (lower) for 120247.....
120247	7790	Binder (adjustable) complete, to turn in upper edge only, for light or medium weight material, Nos. 286D, 120242 and 120244 to 120246.....
120248	7791	Binder (adjustable) complete, to turn in both edges, for light or medium weight material, Nos. 286D and 120242 to 120245.....
120293	7798	Lifting Presser Foot (grooved) for 120207
120294	7798	Vibrating Presser Foot (grooved) for 120207.....
120342	3637	Oiler (copper plated) with 120343 (Accessories).....
120343	3637	Oiler Spout, 3½ in. long, for 120342.....
124535	—	Machine Cushion (rubber) for 124537.....
124536	—	Machine Cushion Tack for 124537.....
124537	—	" " 124535 with 124536 (Trimnings for End and Back Leaf Table).....

SINGER Needles should be used
in SINGER Machines.
These Needles and their Containers
are marked with the
Company's Trade Mark "SIMANCO.***" 1

Needles in Containers marked
"FOR SINGER MACHINES"
are NOT **SINGER** made needles. 2

PLATE 685—FULL SIZE

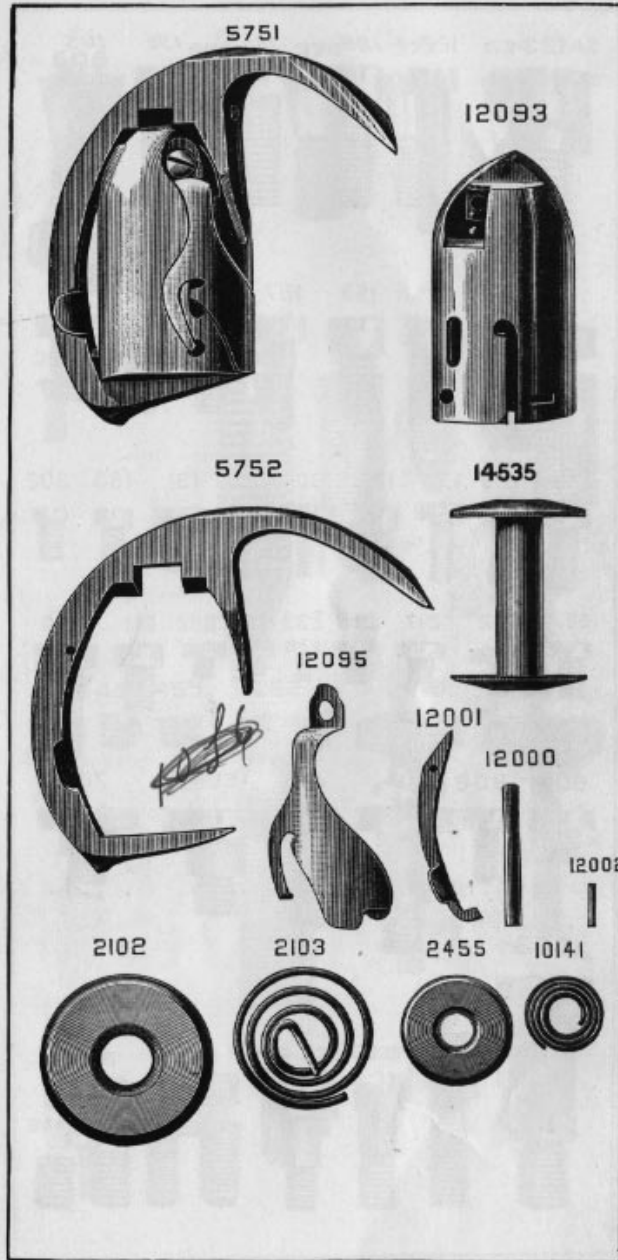


PLATE 691—FULL SIZE

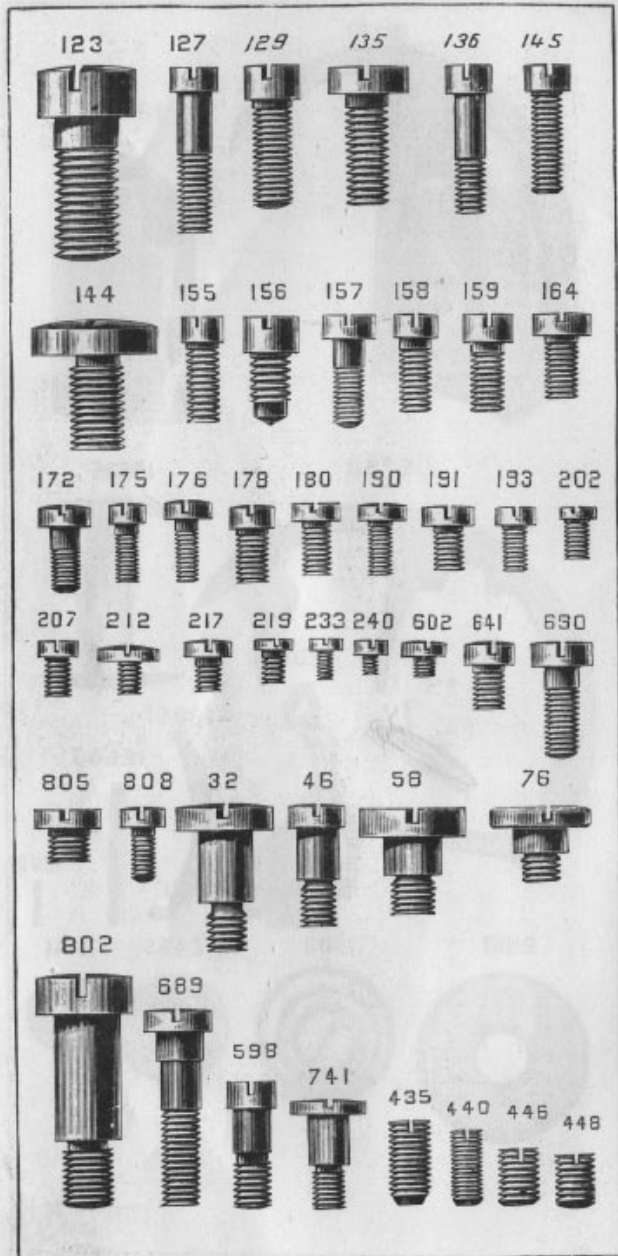


PLATE 692—FULL SIZE

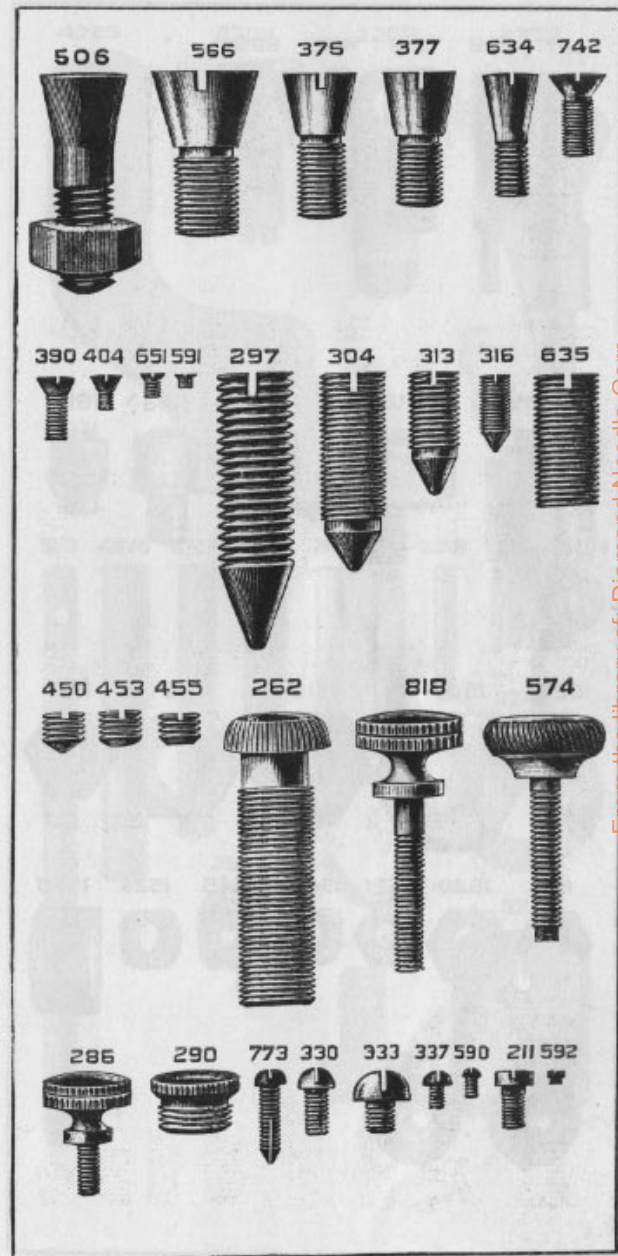


PLATE 693—FULL SIZE

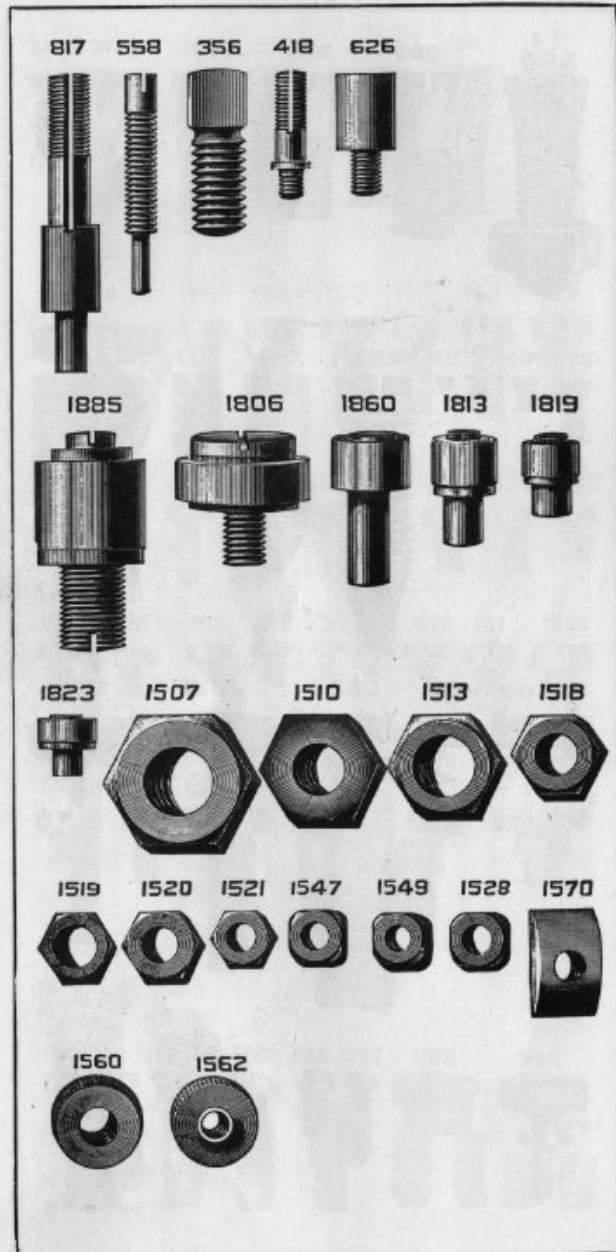
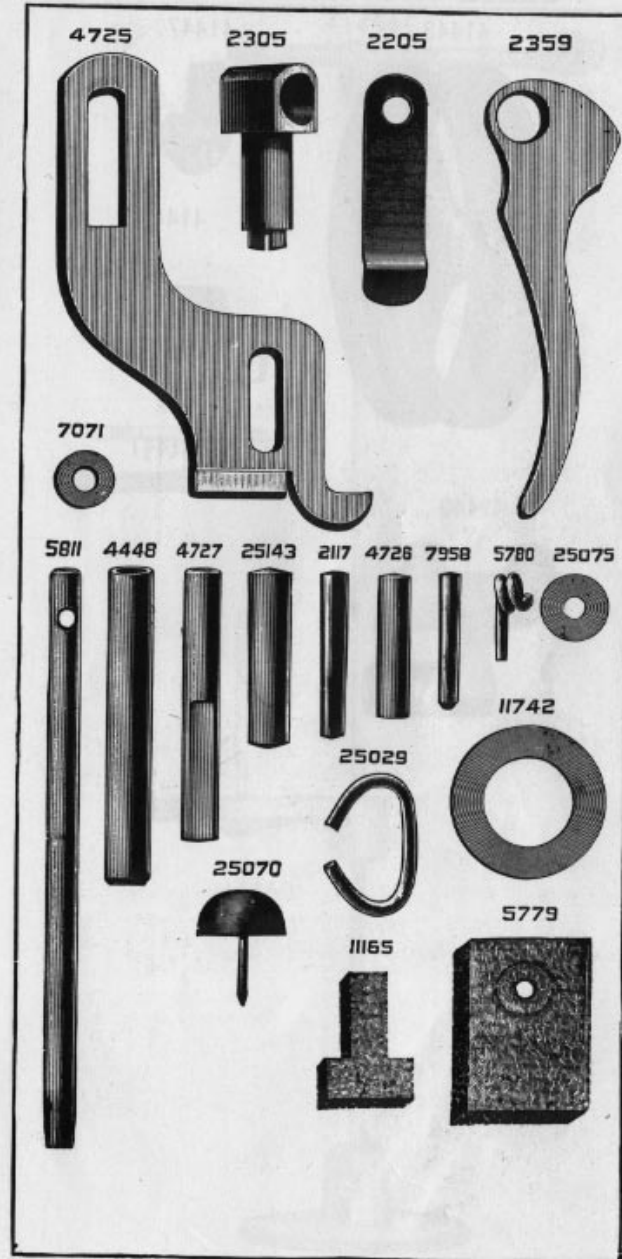


PLATE 695—FULL SIZE



From the library of: Diamond Needle Corp

PLATE 3581—ONE-HALF SIZE

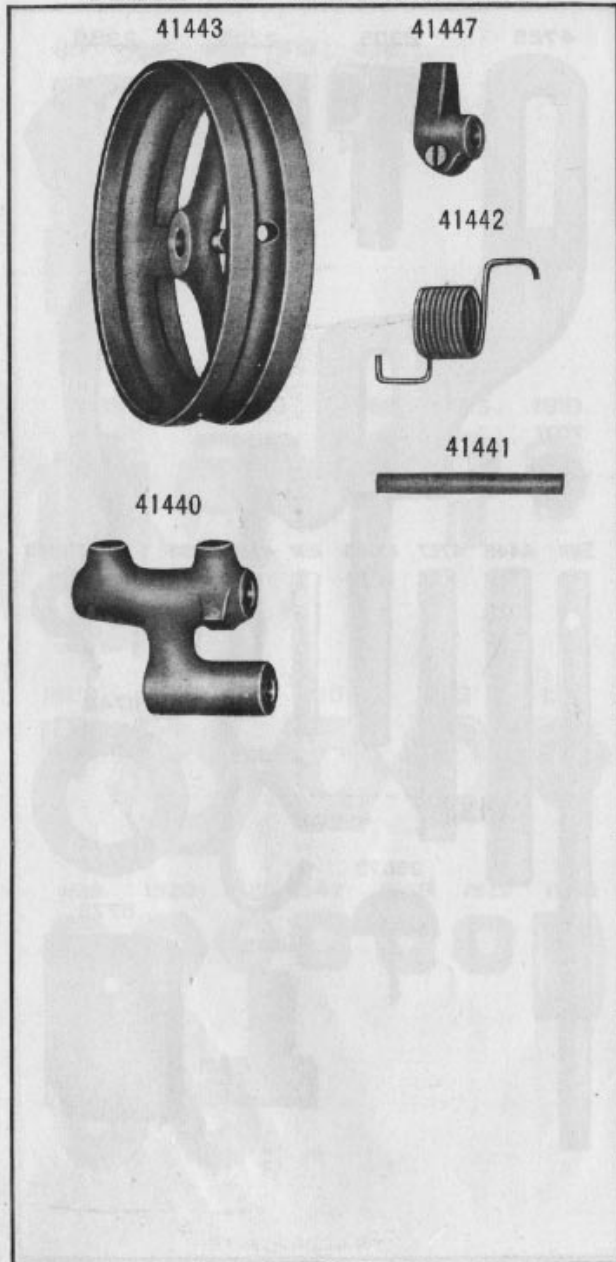


PLATE 3582—ONE-FOURTH SIZE



From the library of: Diamond Needle Corp

PLATE 3583—FULL SIZE

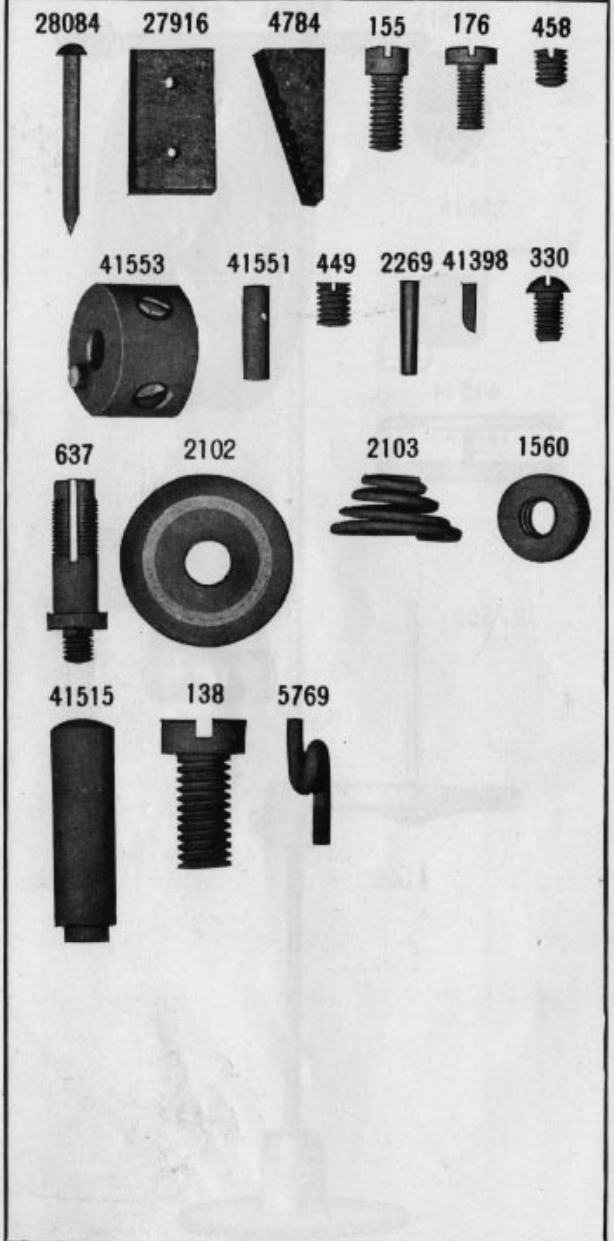
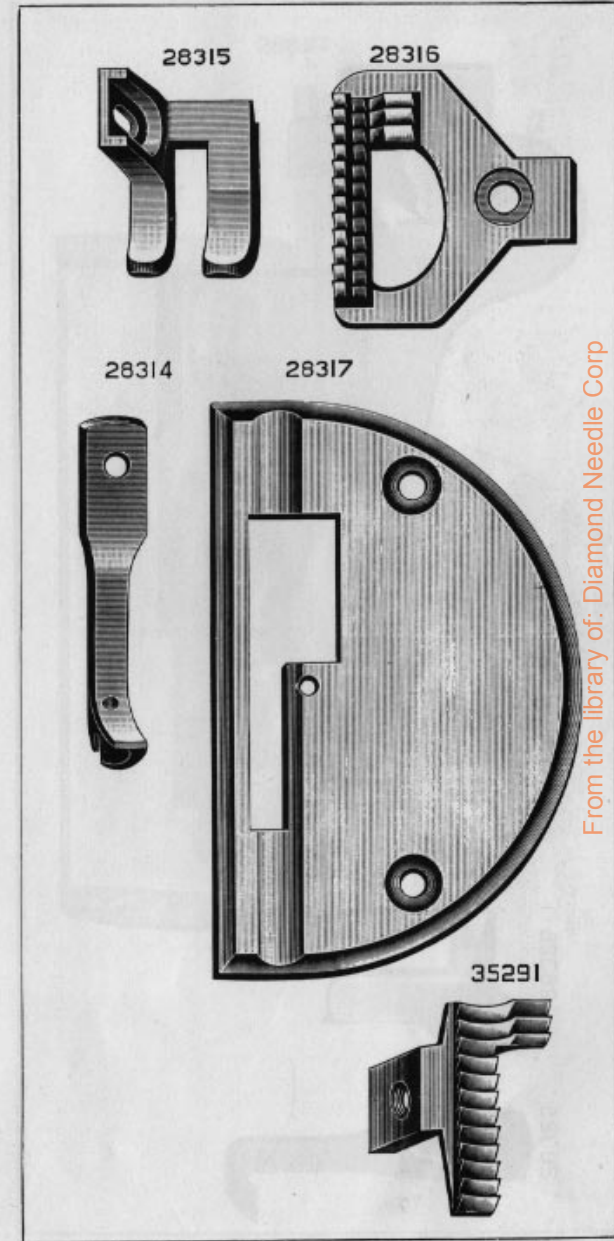


PLATE 3603—FULL SIZE



From the library of: Diamond Needle Corp

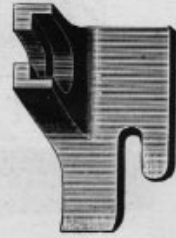
28325



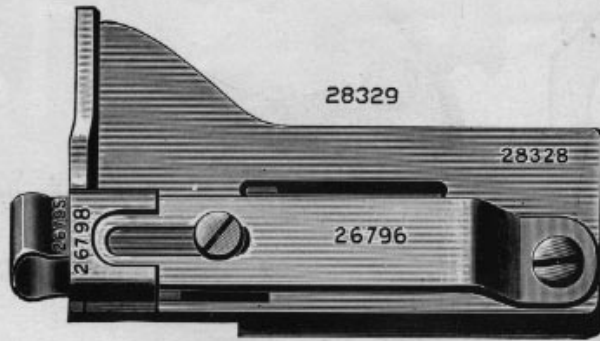
28326



28327



28329

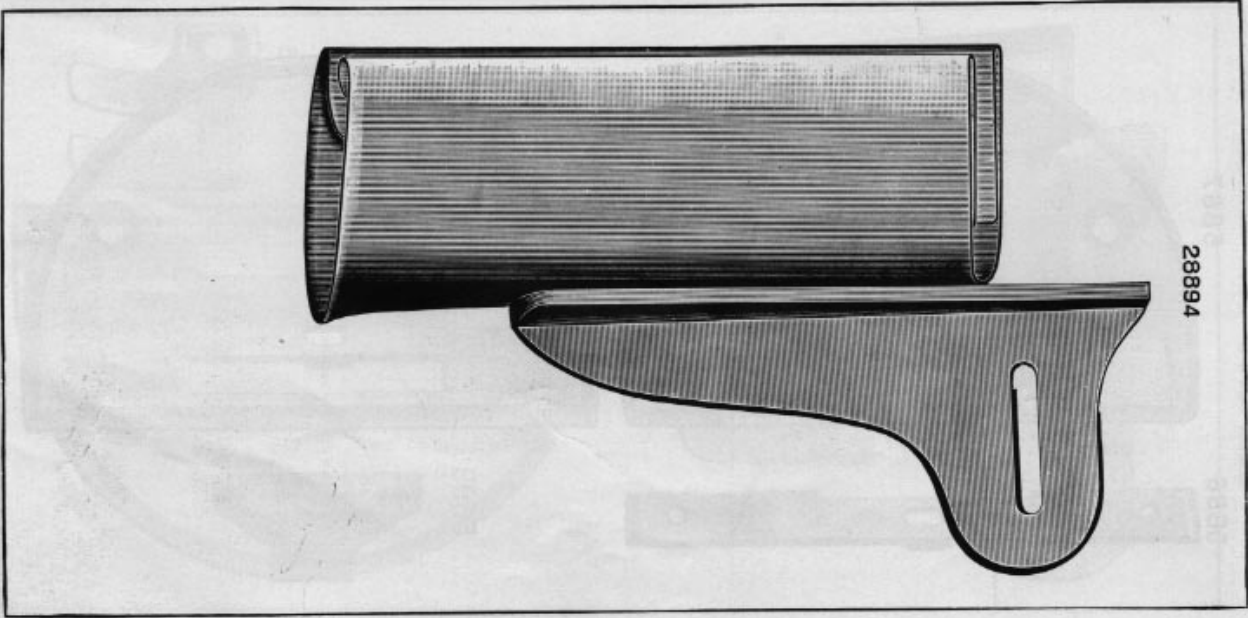


28328

26796

26798

PLATE 3608—FULL SIZE



23894

PLATE 3612—FULL SIZE

PLATE 3618—FULL SIZE

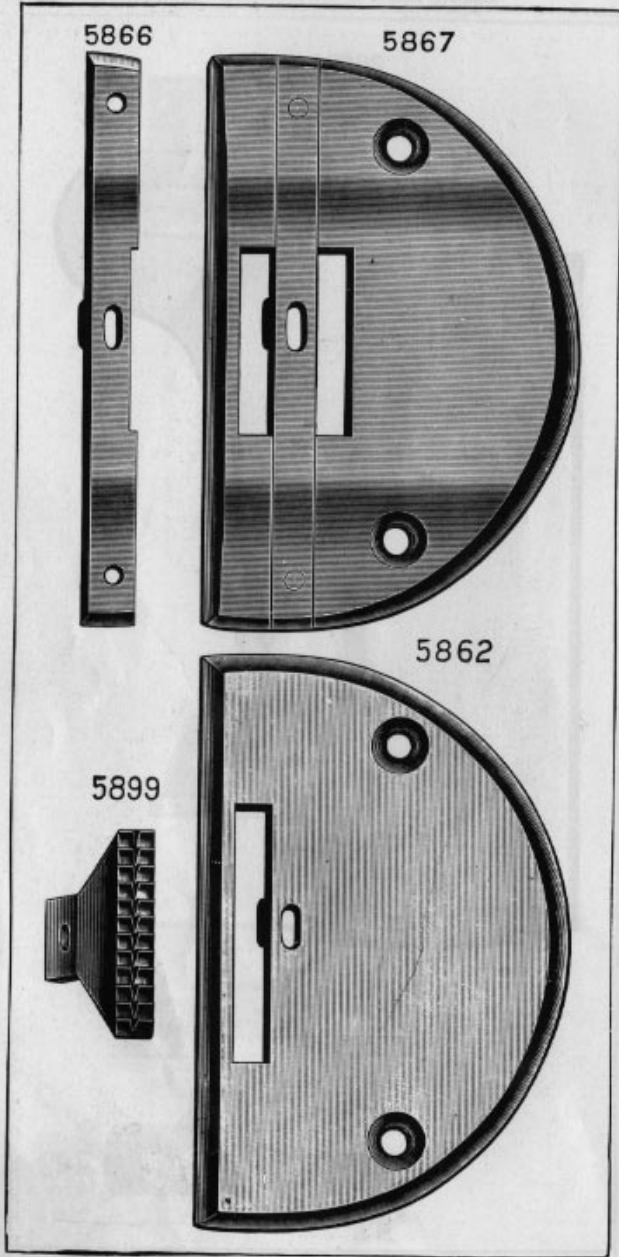


PLATE 3624—FULL SIZE

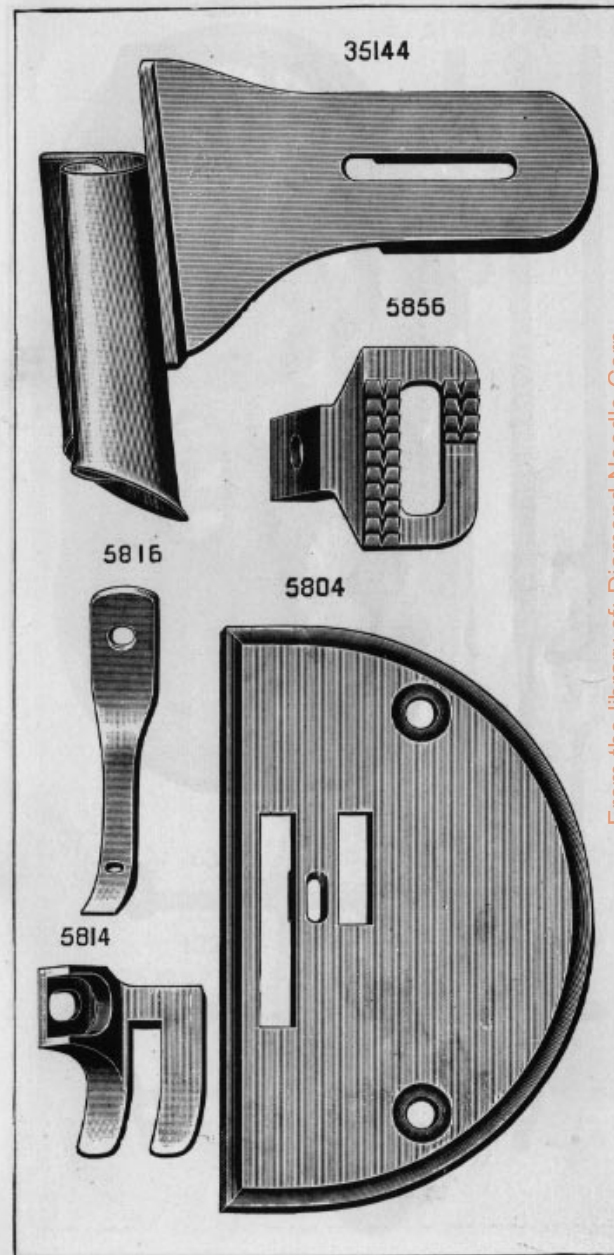


PLATE 3627—ONE-FOURTH SIZE

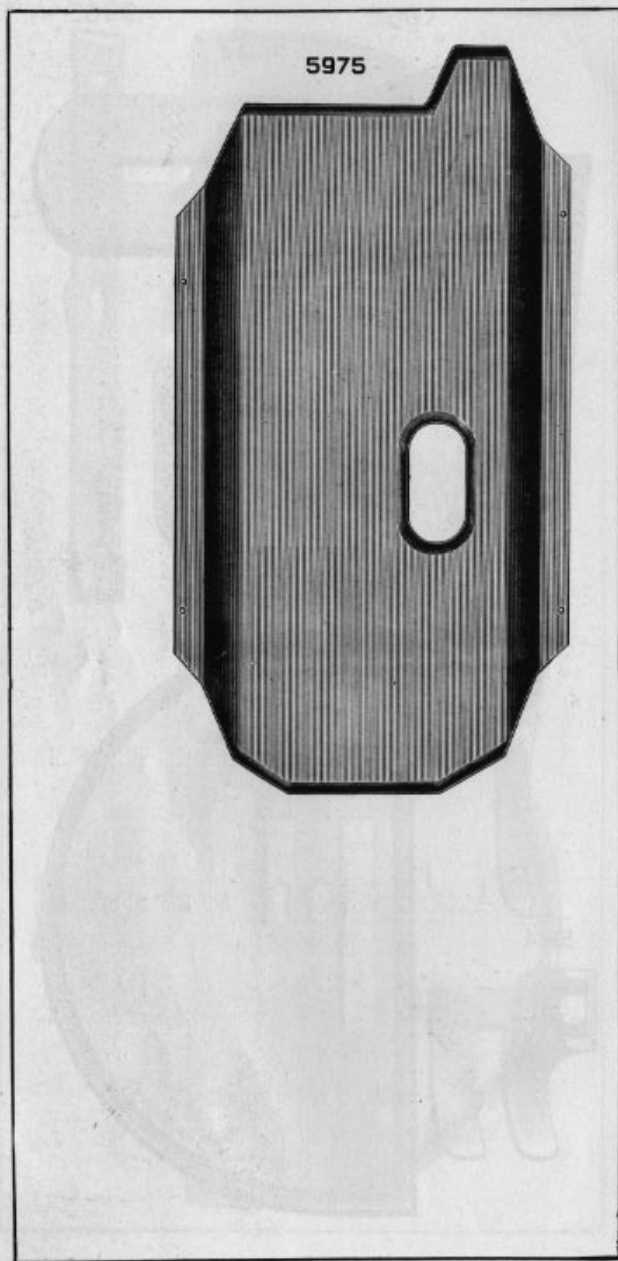


PLATE 3628—ONE-FOURTH SIZE

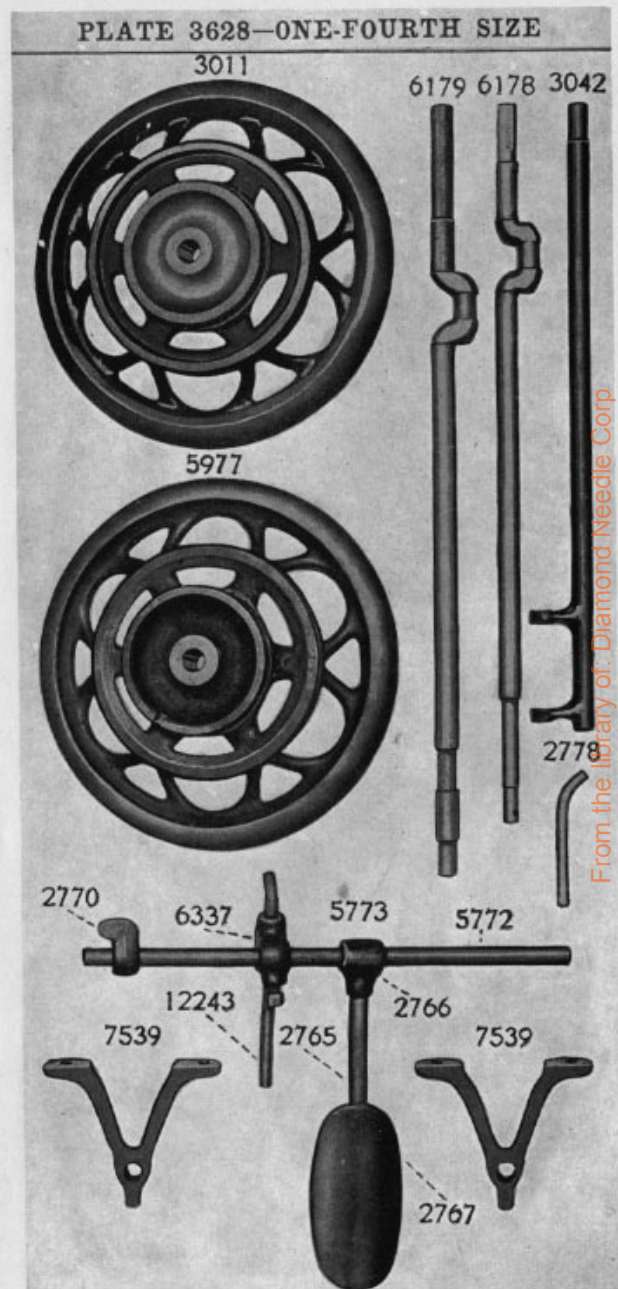


PLATE 3629—ONE-HALF SIZE

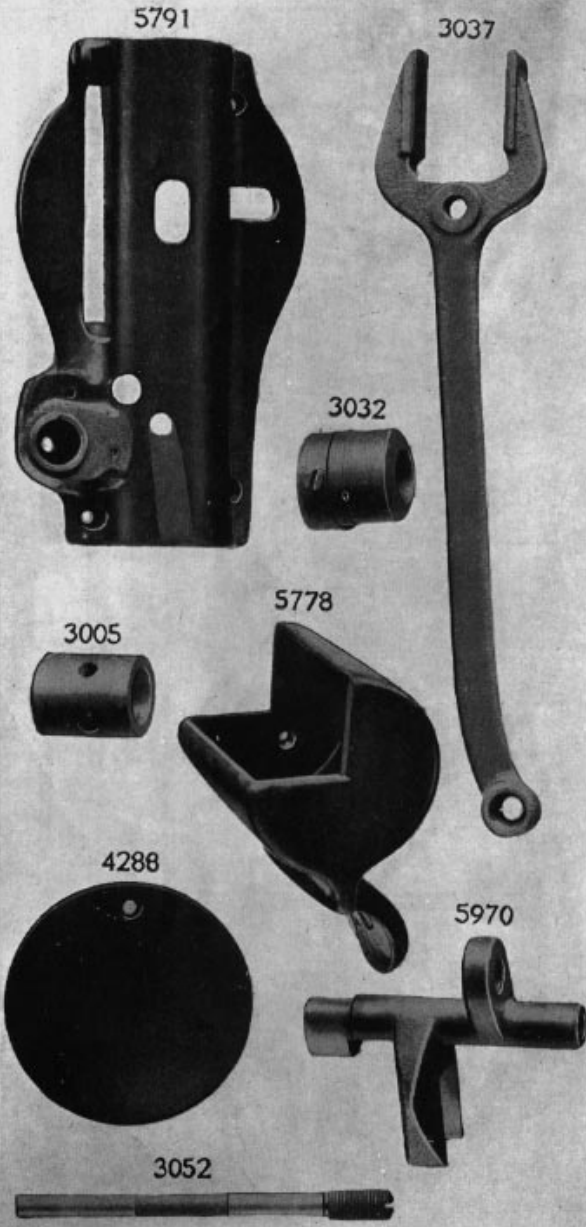
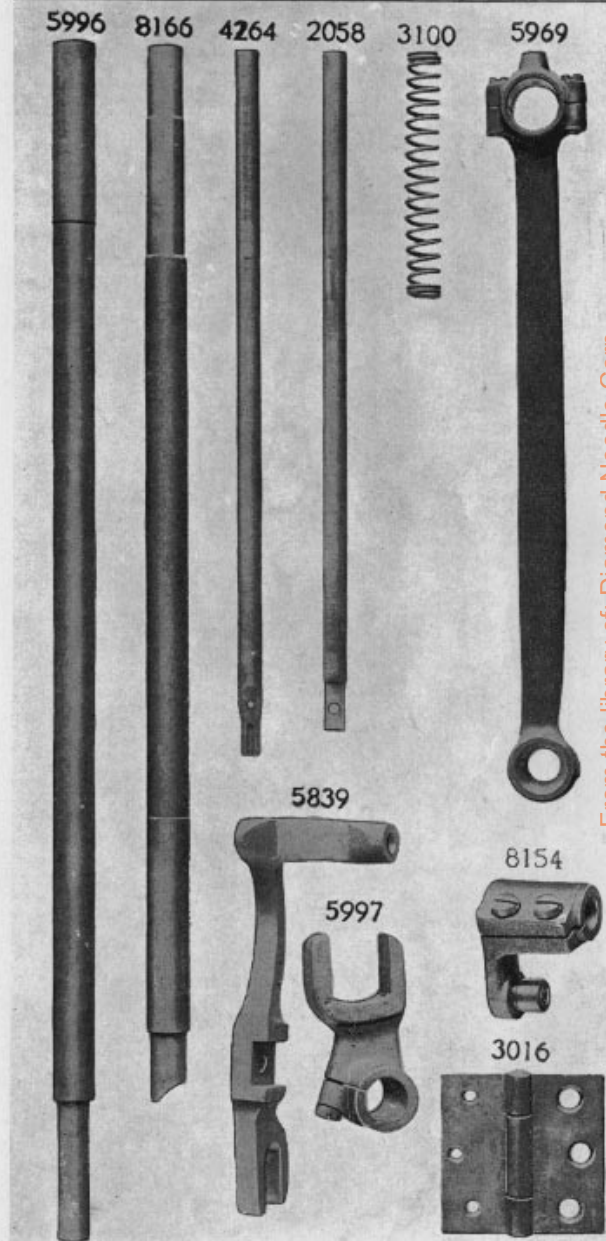


PLATE 3630—ONE-HALF SIZE



From the library of: Diamond Needle Corp

PLATE 3631—FULL SIZE

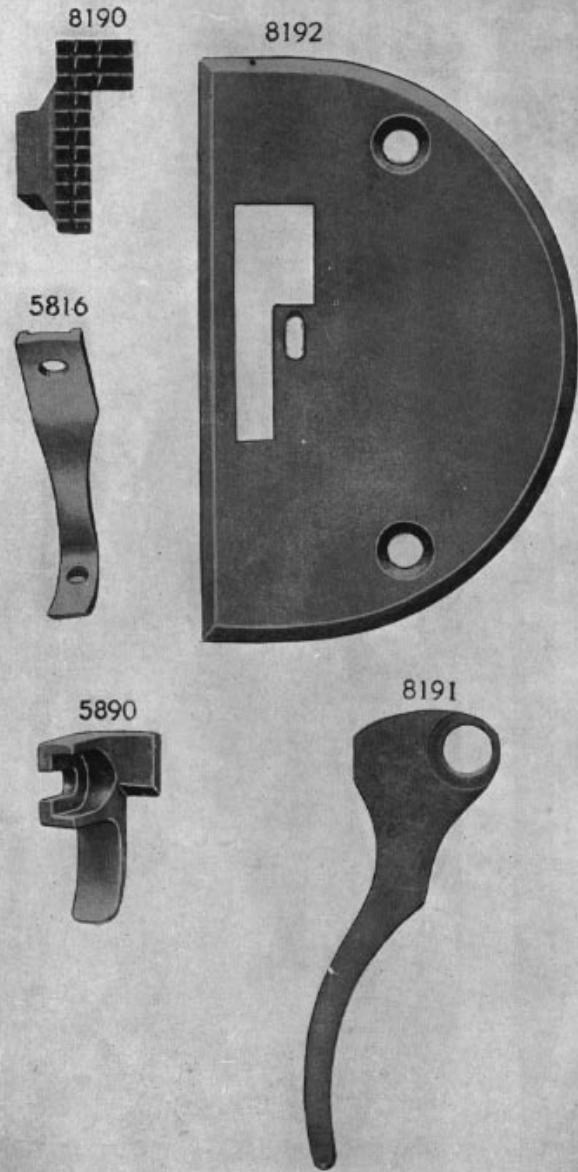


PLATE 3632—FULL SIZE

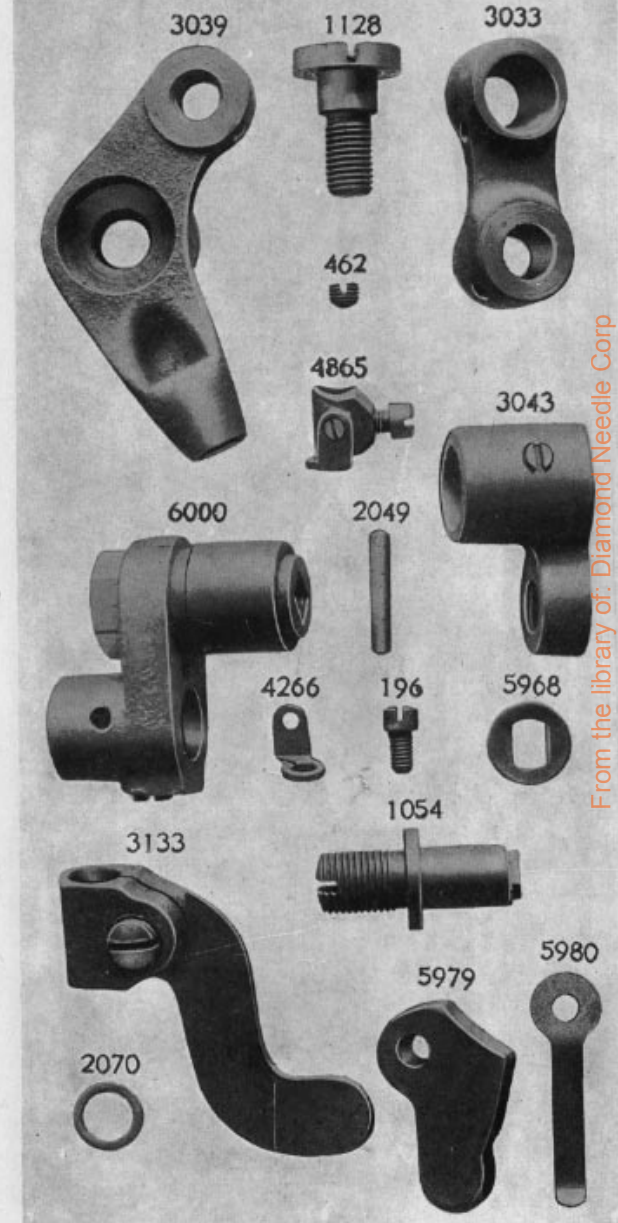


PLATE 3633—FULL SIZE

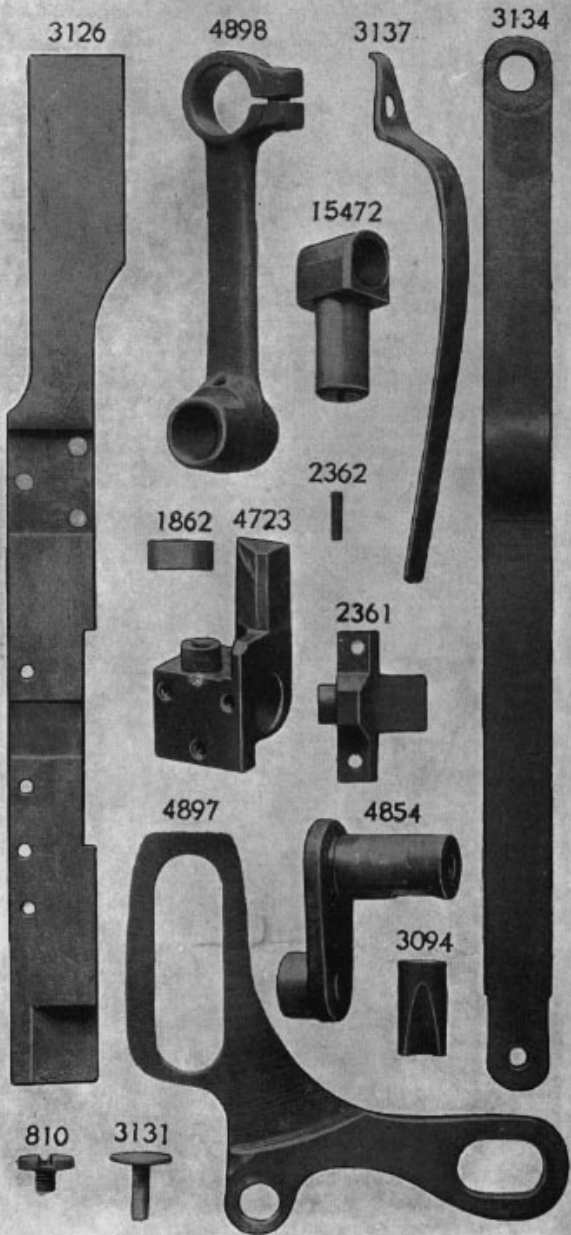
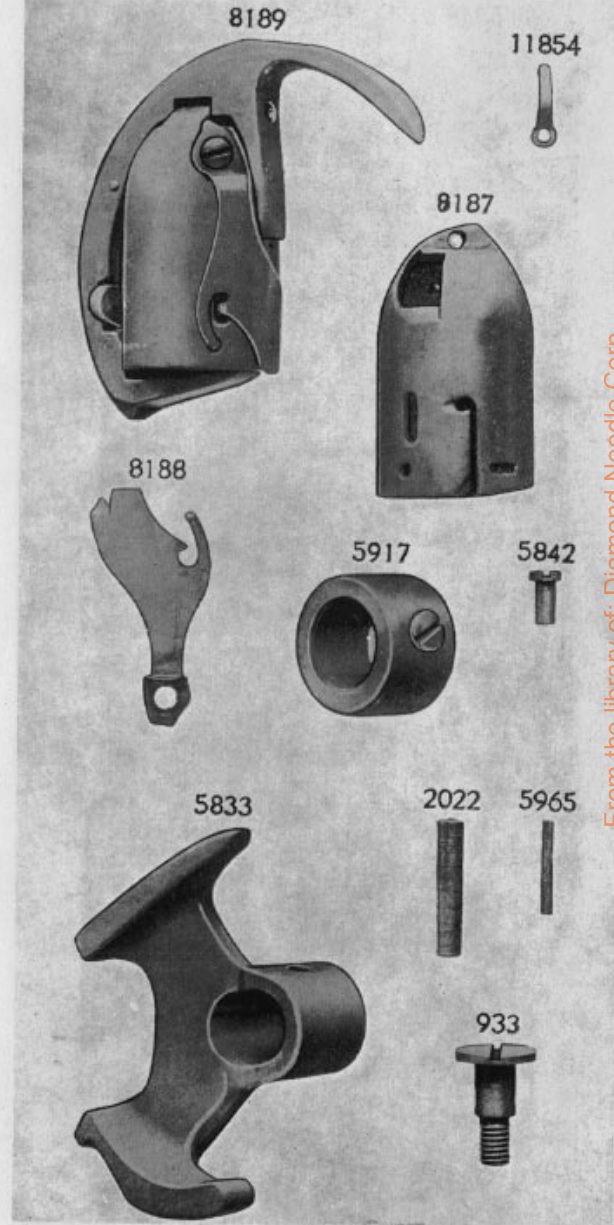


PLATE 3634—FULL SIZE

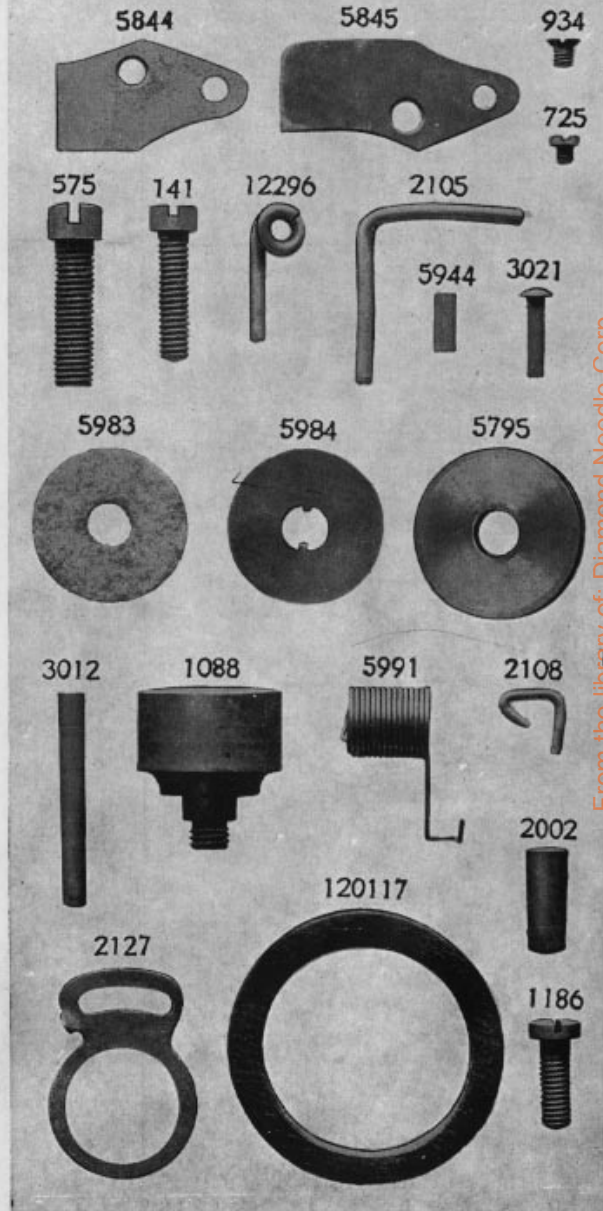


From the library of: Diamond Needle Corp

PLATE 3635—ONE-HALF SIZE



PLATE 3636—FULL SIZE



From the library of: Diamond Needle Corp

PLATE 3637—ONE-HALF SIZE

120342 41400 26485 26026

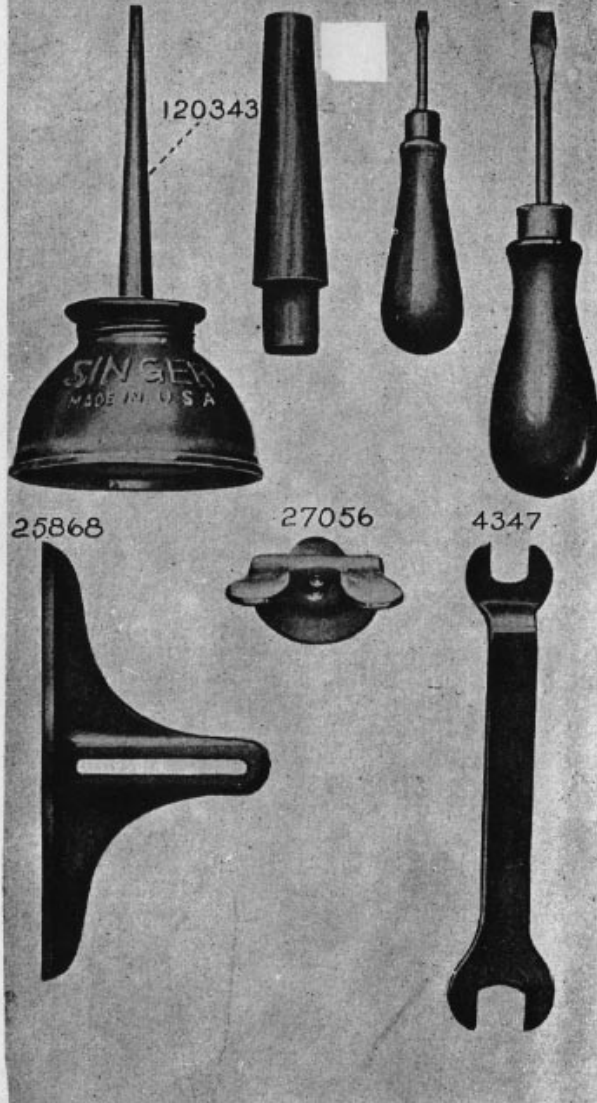
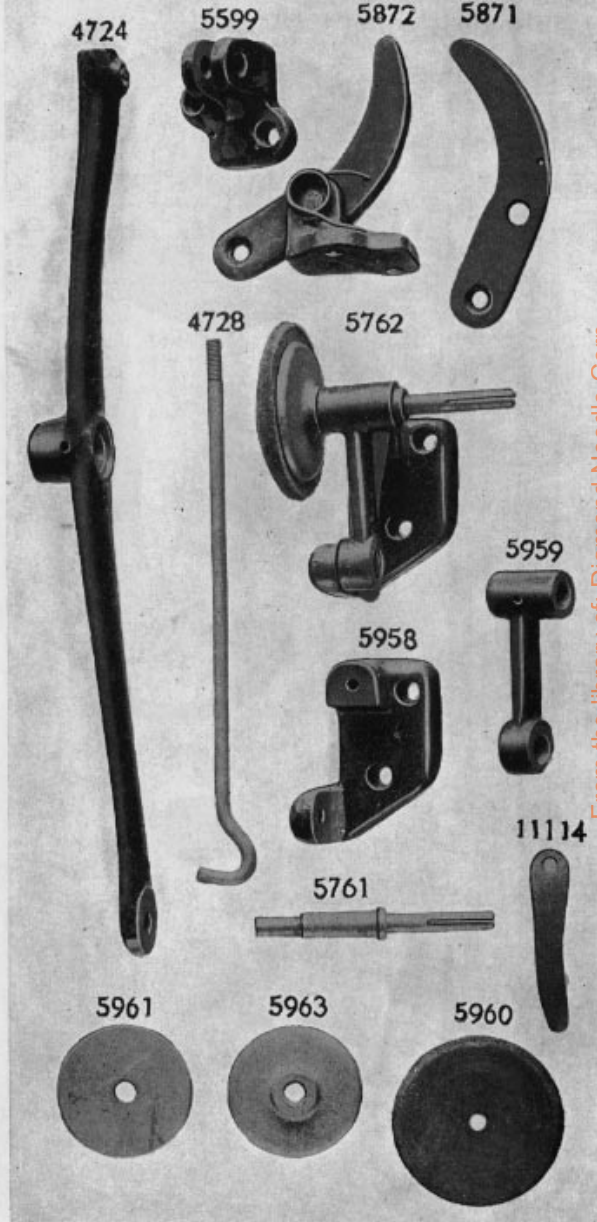


PLATE 3638—ONE-HALF SIZE

4724 5599 5872 5871



From the library of: Diamond Needle Corp

PLATE 3639—ONE-HALF SIZE

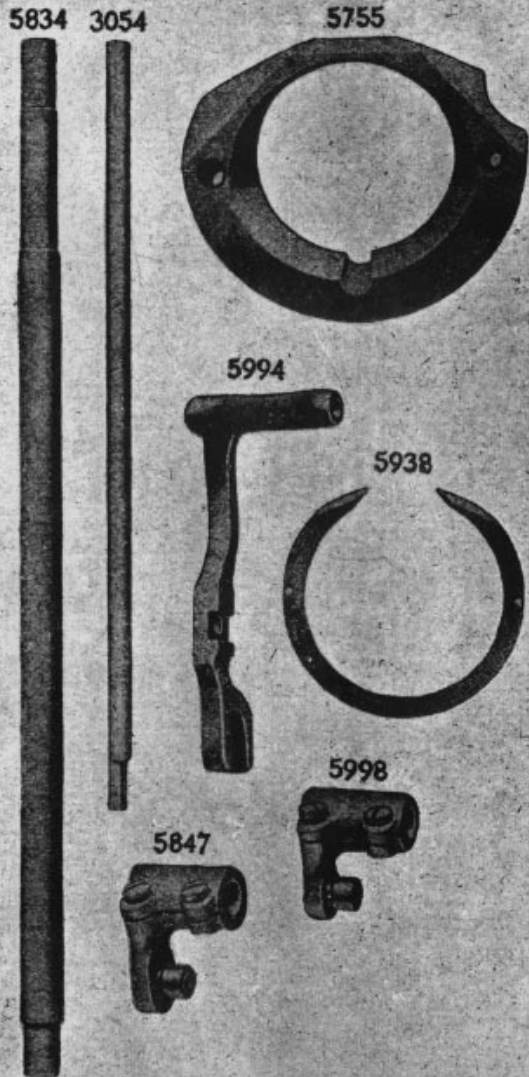
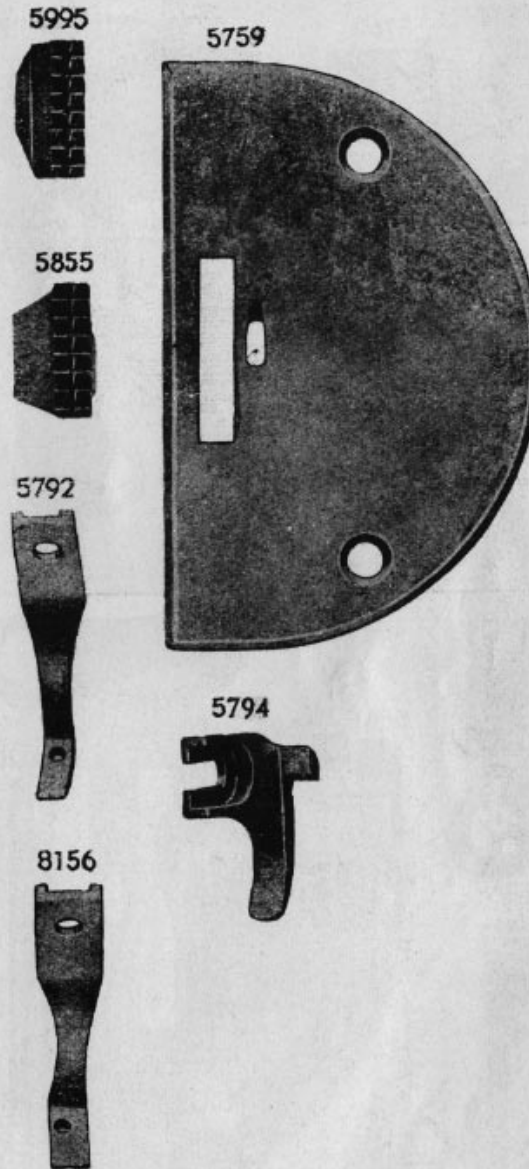


PLATE 3640—FULL SIZE



From the library of: Diamond Needle Corp

PLATE 3641—FULL SIZE

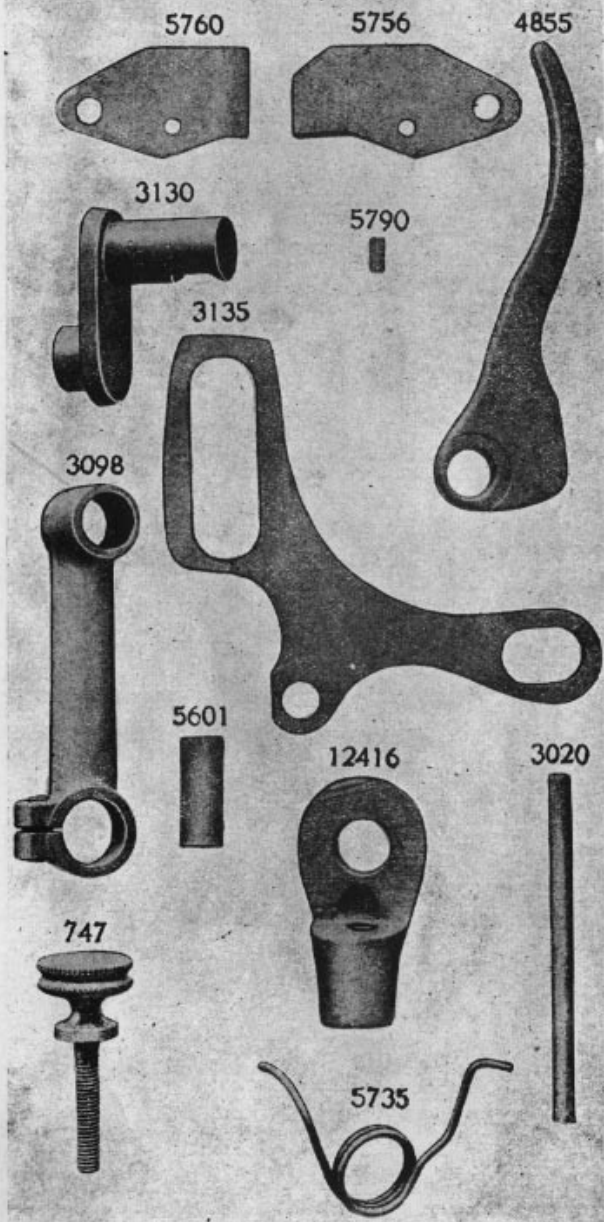
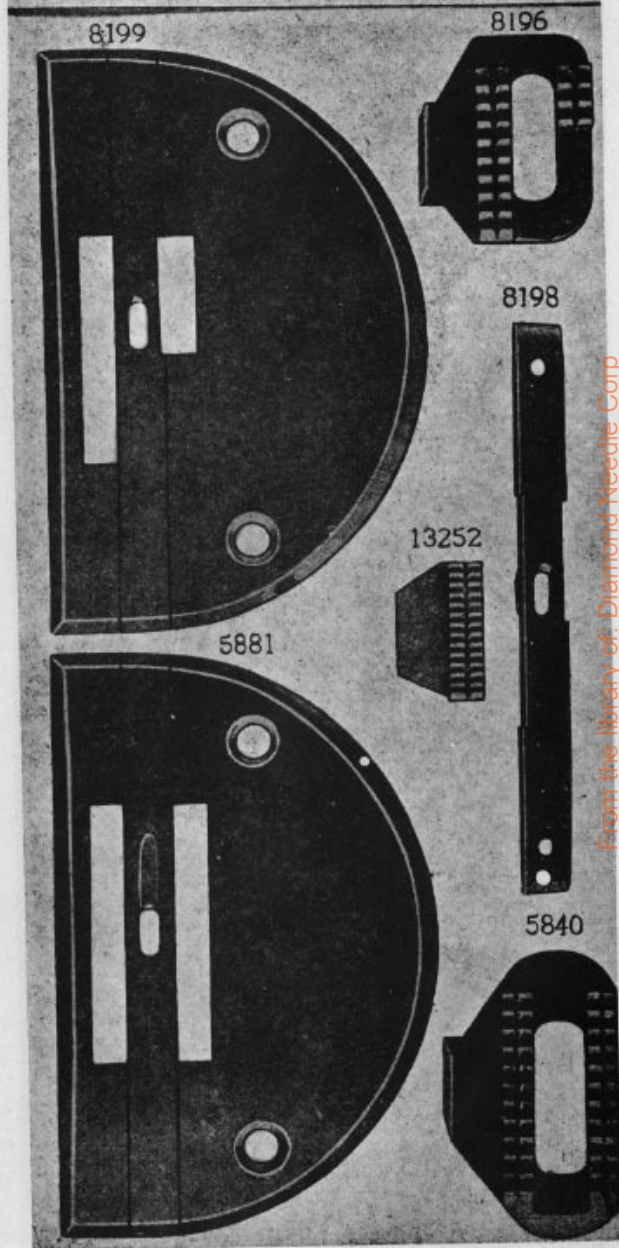


PLATE 3647—FULL SIZE



From the library of: Diamond Needle Corp

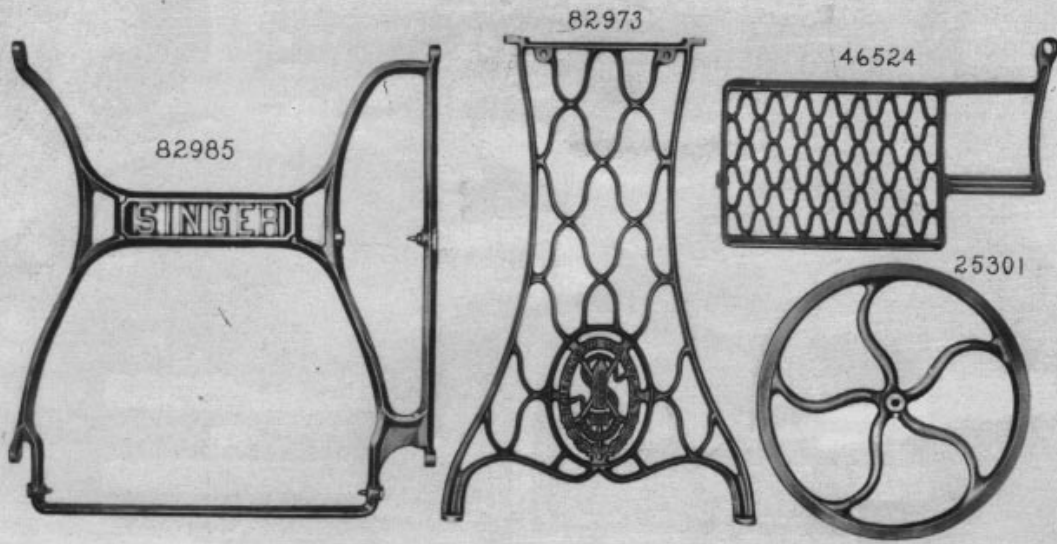
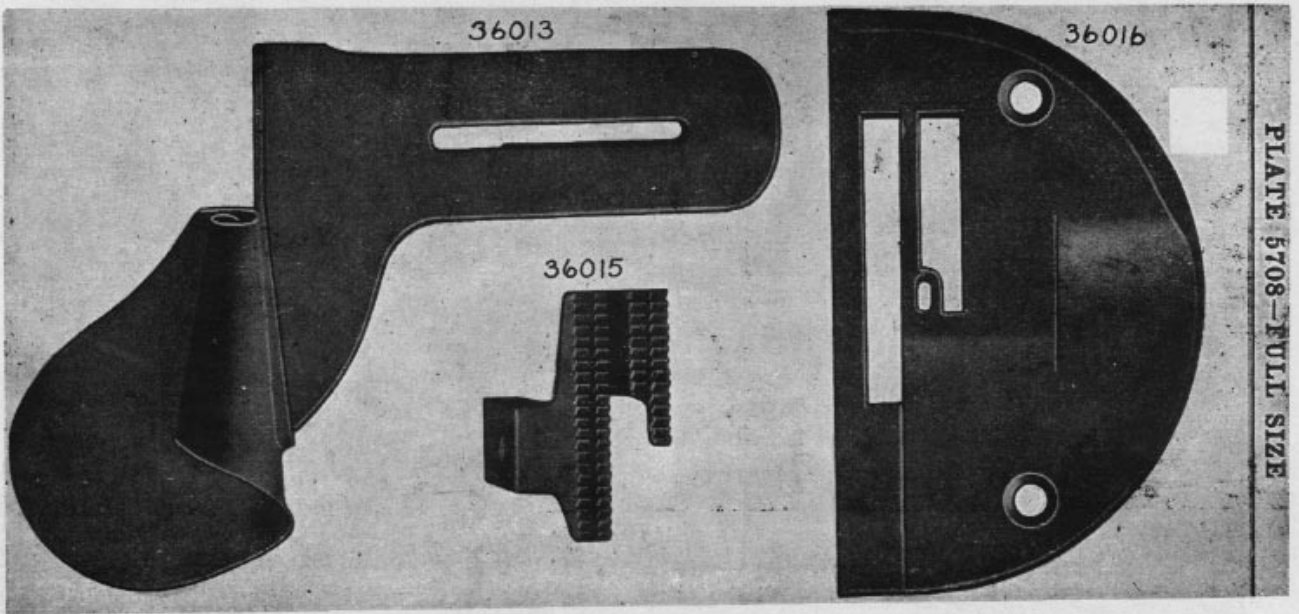


PLATE 5216—ONE-NINTH SIZE



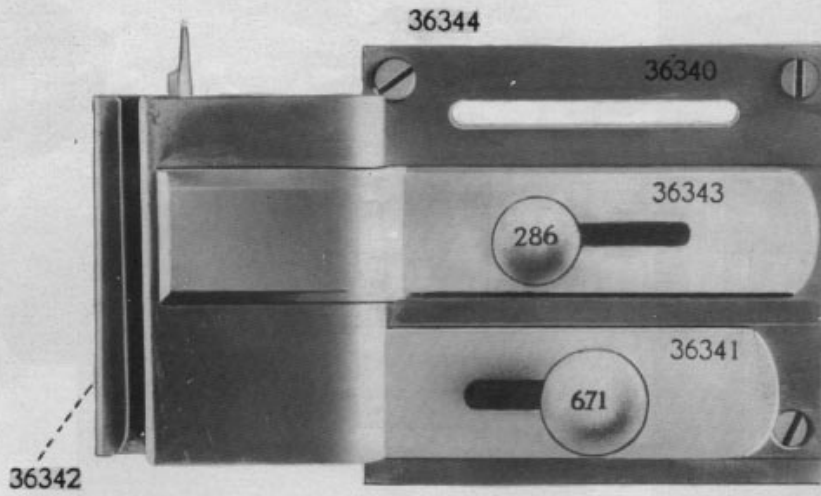


PLATE 5807-FULL SIZE

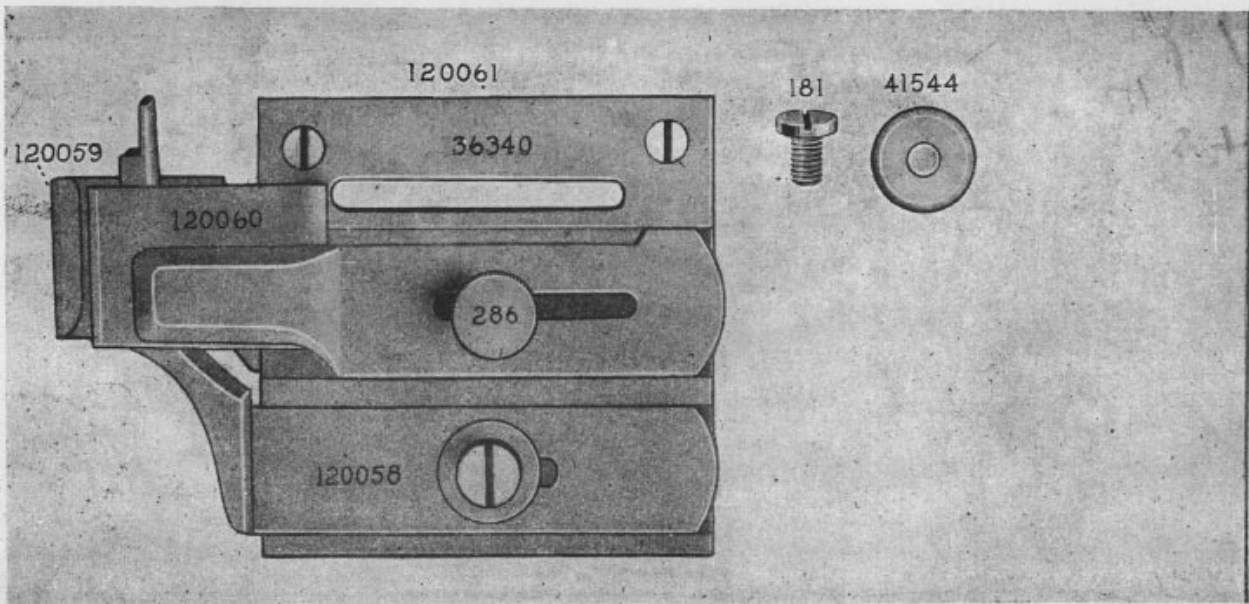


PLATE 5830-FULL SIZE

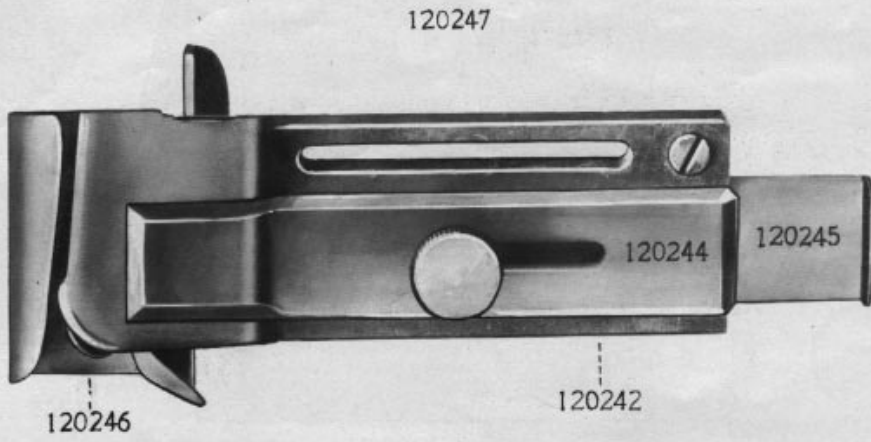


PLATE 7790—FULL SIZE

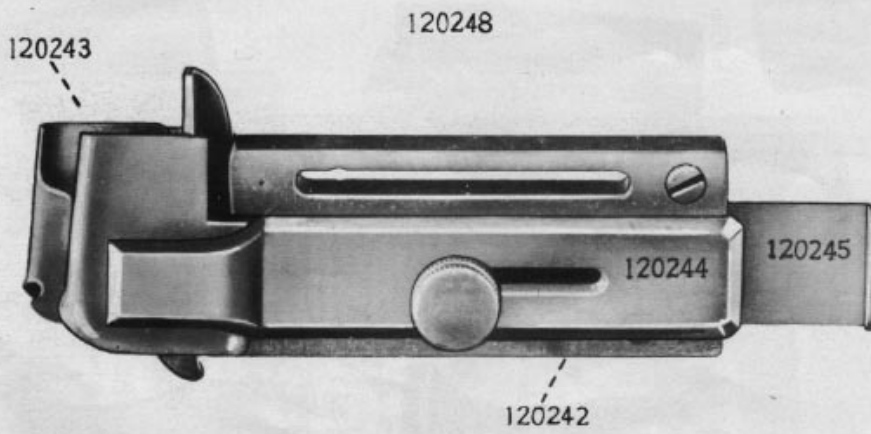
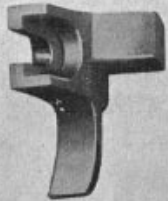


PLATE 7791—FULL SIZE

PLATE 7796—FULL SIZE

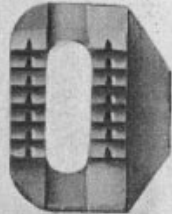
35365



35364



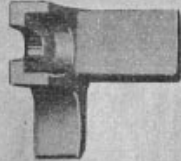
8153



36345



36346



26996



28323

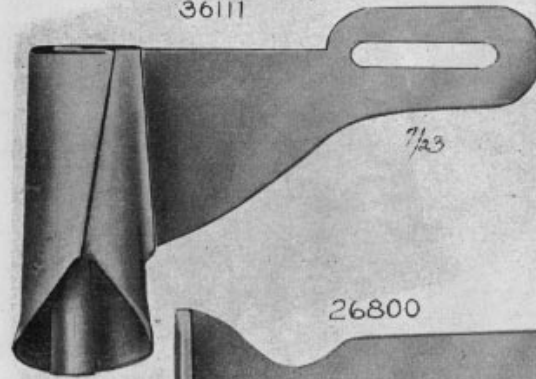


28324

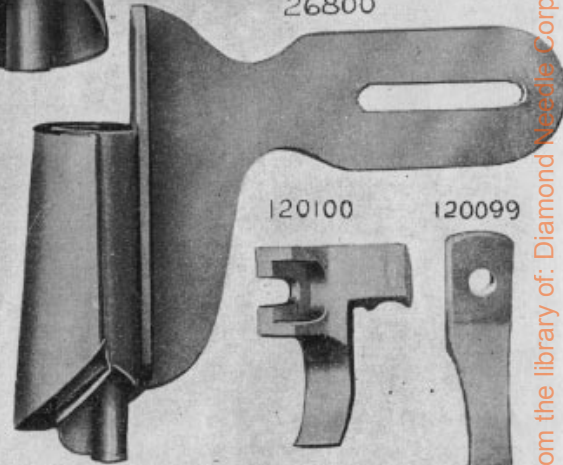


PLATE 7797—FULL SIZE

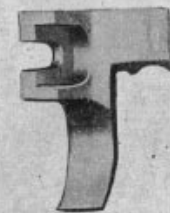
36111



26800



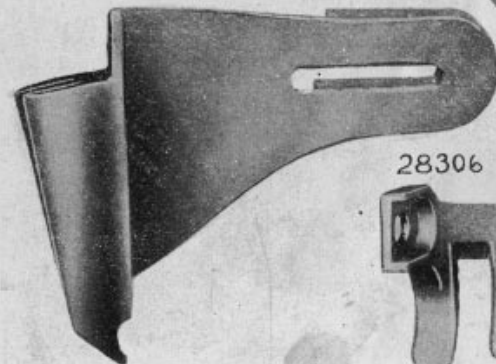
120100



120099



28307



28306



From the library of: Diamond Vessels Corp

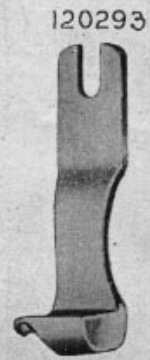
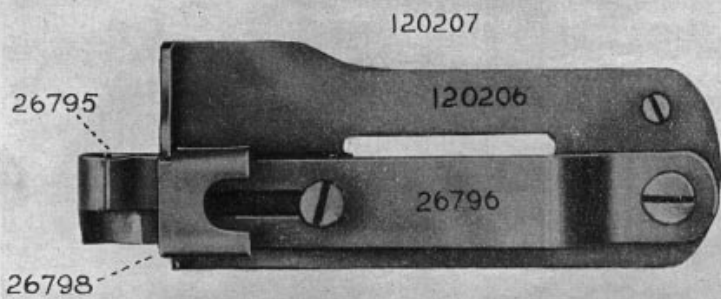
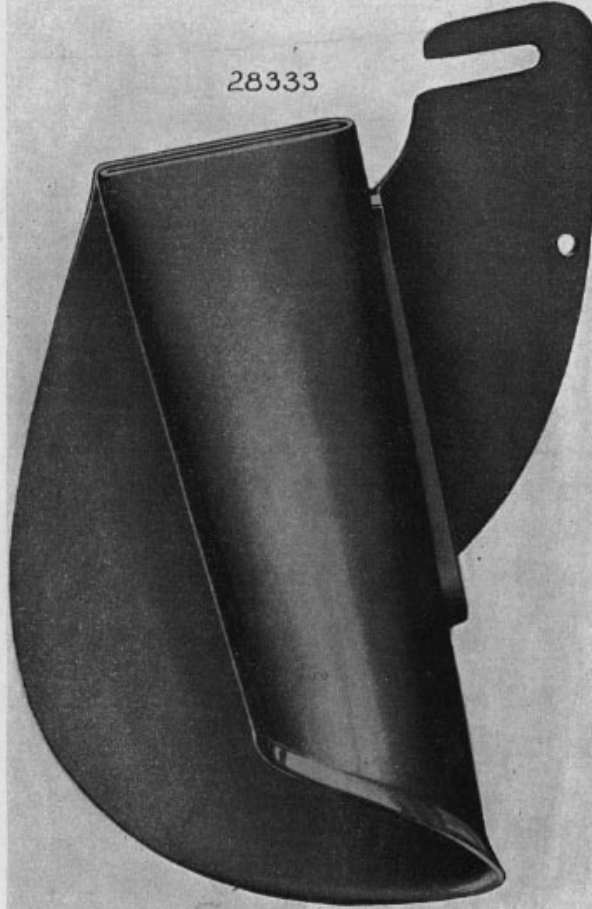


PLATE 7798—FULL SIZE

PLATE 7799—FULL SIZE

28333



From the library of: Diamond Needle Corp

PLATE 7800—ONE-HALF SIZE

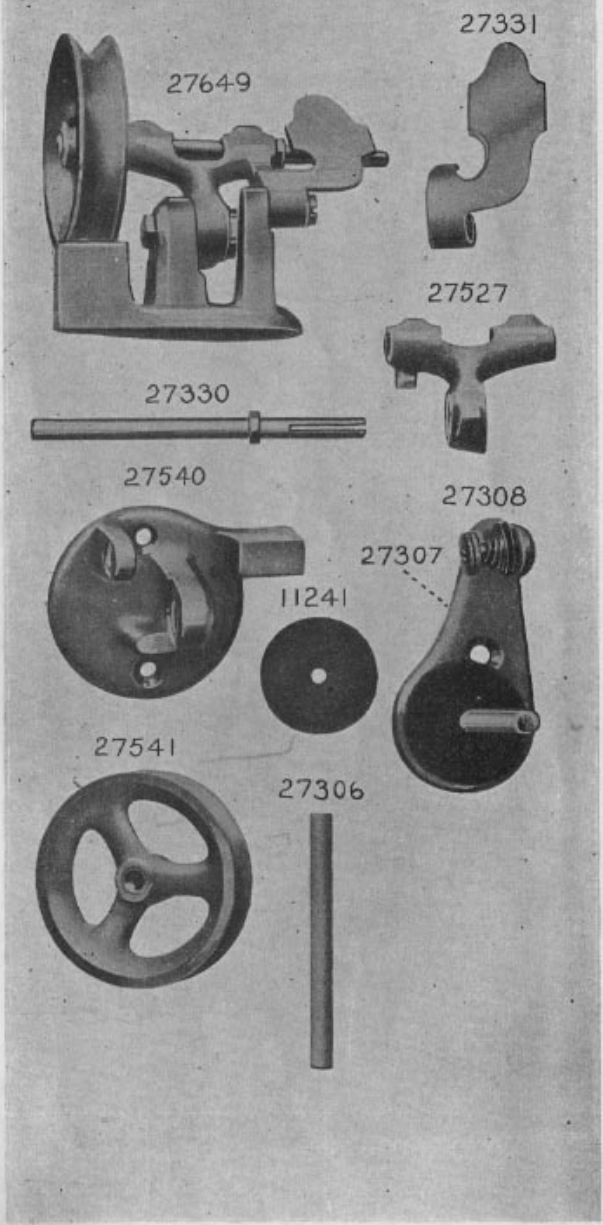
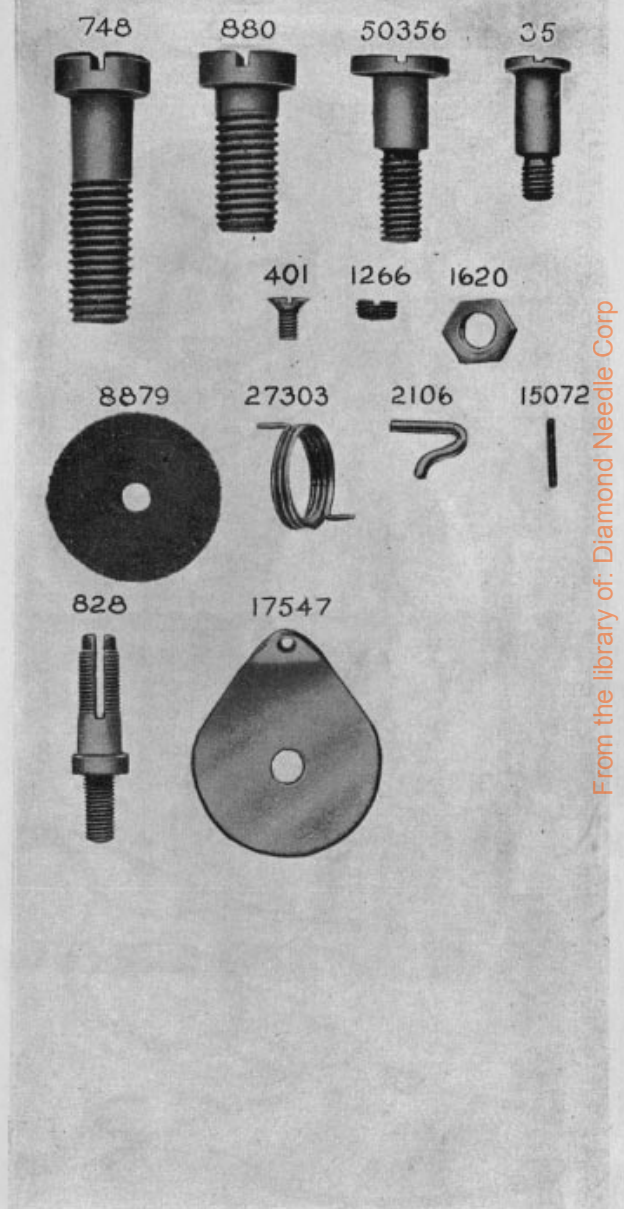


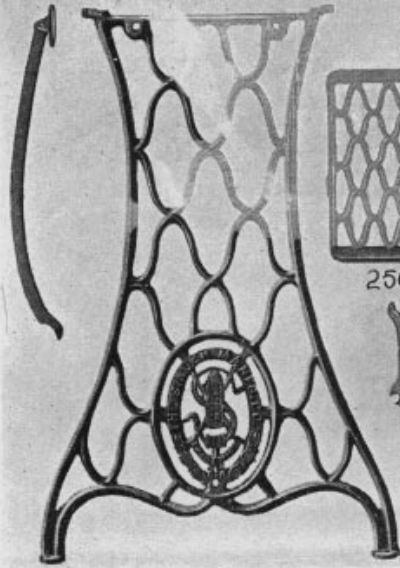
PLATE 7801—FULL SIZE



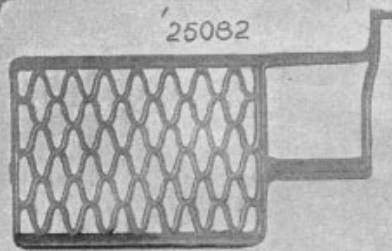
From the library of: Diamond Needle Corp

25057

46522



25082



25086



25010



25003



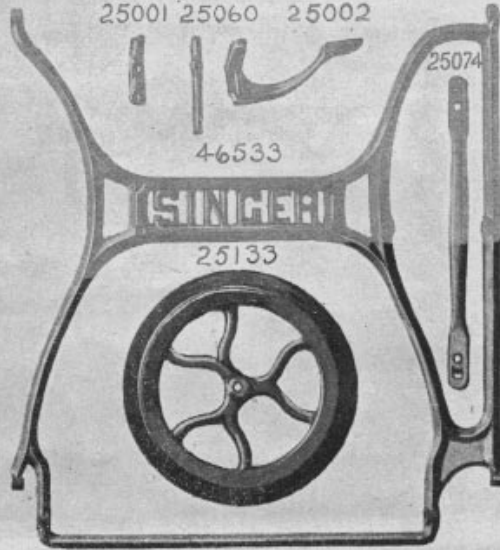
25149

25151

25001

25060

25002



25074

46533

25133

PLATE 7802-ONE-NINTH SIZE

46662

46663

46528

25124

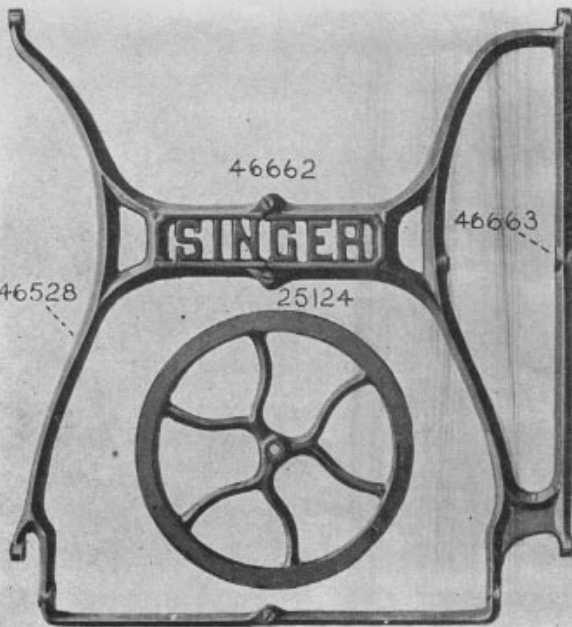
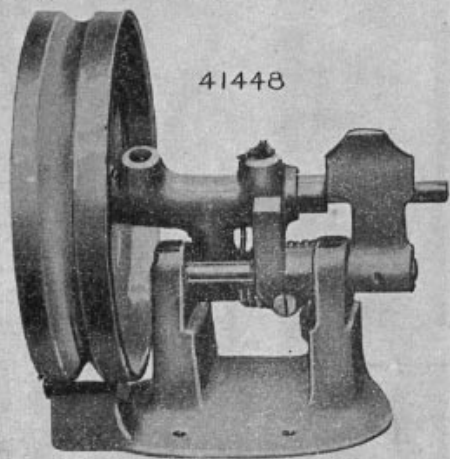
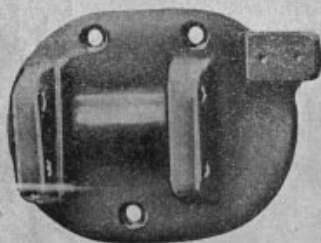


PLATE 7803-ONE-EIGHTH SIZE

PLATE 7804—ONE-HALF SIZE



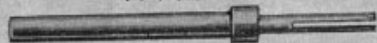
41439



41445



41444

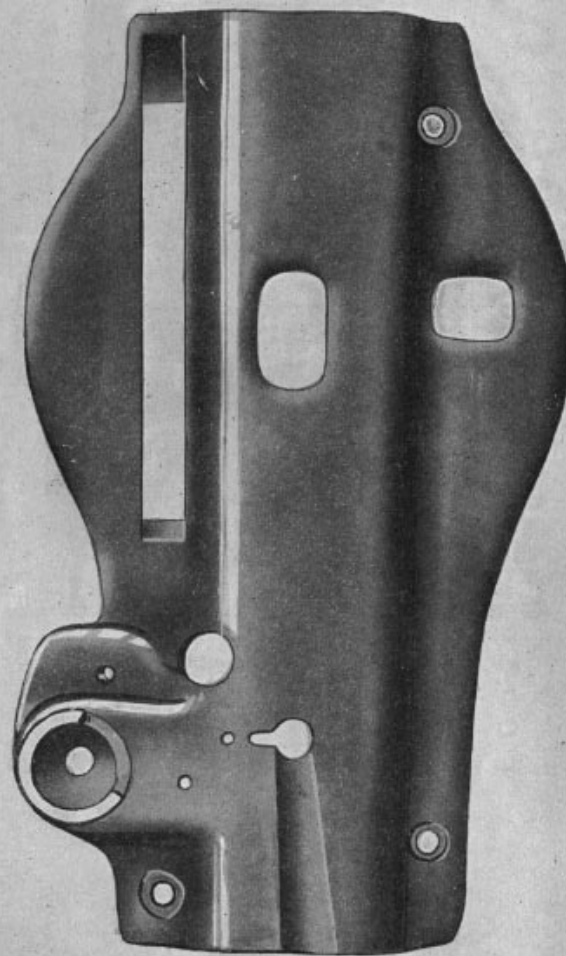


41446



PLATE 7807—FULL SIZE

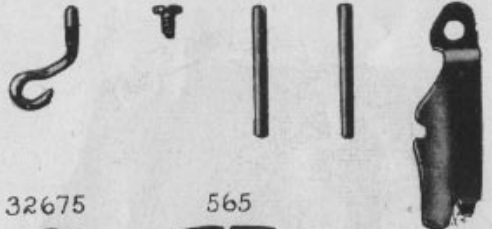
13254



From the library of: Diamond Needle Corp

PLATE 7808—FULL SIZE

56870 229 13266 13260 13264



32675



565



29633



13261



124537

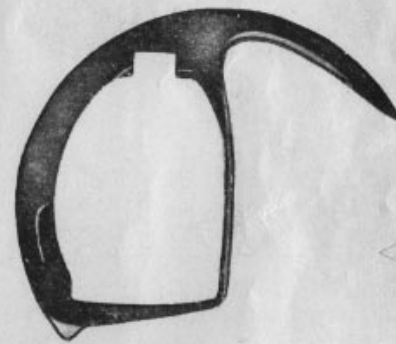


PLATE 7809—FULL SIZE

13265



13262



13258



From the library of: Diamond Needle Corp